

方大控股

FANGDA HOLDING

2022 CATALOG



CARBIDE TIPPED MASONRY DRILL BITS

1-22



CARBIDE TIPPED MASONRY DRILL BIT SETS

23-25



CHISELS

26-28



HOLE SAWS

29-30



HSS STRAIGHT SHANK TWIST DRILL

31-32



ROUTER BIT SETS

33-42



ROUTER BITS

43-64

公司简介



方大控股有限公司始创于1987年，公司专业生产经营钻头、凿子、麻花钻、锯片、开孔器、木工刀具、硬质合金等20多个系列5000多种规格的产品，并投资地产、金融、PE等领域。现公司在全国各地设有200多家销售部及特约经销处，并在俄罗斯、乌克兰、阿联酋、越南等国家设有特约经销处，产品远销欧美、中东、东南亚、非洲等80多个国家与地区。

创新、和谐、诚信、责任是方大发展的前提与基础。公司拥有雄厚的技术力量，完善的检测试验设备，先进的经营管理理念。在乐清市同行业中率先通过ISO9001质量管理体系、ISO14001环境管理体系和ISO45001职业健康安全管理体系认证、SA8000社会责任管理体系、PGM认证。

方大自创建企业以来，一直坚持“社会关爱企业，企业回馈社会”的理念，勇于承担社会责任，为扶贫救灾、公共道路和新农村建设、贫困大学生资助、希望学校建设及中华红丝带基金等公益事业捐资。面对经济全球化的挑战，方大将继续立足五金工具行业，坚持以市场为导向的经营理念，坚持“国际化、科技化、产业化”的发展方向，大力引进先进设备、技术和优秀人才，整合资源，发挥优势，努力将“方大”塑造成国际五金界长盛不衰的知名企业。

C Company Overview



Fangda Holdings Co., Ltd. was founded in 1987. The company specializes in the production and operation of drill bits, chisels, twist drills, saw blades, hole saw, woodworking tools, cemented carbide and more than 20 series of products with more than 5000 specifications. It also invests in real estate, Finance, PE and other fields. At present, the company has more than 200 sales departments and special sales offices throughout the country, and has special sales offices in Russia, Ukraine, the United Arab Emirates, Vietnam and other countries. The products are exported to more than 80 countries in Europe, America, the Middle East, Southeast Asia, and Africa.

Innovation, harmony, honesty and responsibility are the premise and foundation for the development of Fangda. The company has strong technical force, perfect testing and testing equipment, and advanced management concepts. In the same industry in Yueqing City, it is the first to pass the ISO9001 quality management system, ISO14001 environmental management system and ISO45001 occupational health and safety management system certification, SA8000 social responsibility management system, and PGM certification.

Since founding the enterprise, Fangda has always adhered to the concept of "social care for enterprises, and enterprises giving back to society", and has the courage to assume social responsibilities for poverty alleviation and disaster relief, public roads and new rural construction, financial assistance for poor college students, hope school construction and China Red Ribbon Fund, etc. Donations for public welfare undertakings. Faced with the challenges of economic globalization, Fangda will continue to base itself on the hardware and tool industry, adhere to the market-oriented business philosophy, adhere to the development direction of "internationalization, technology and industrialization", and vigorously introduce advanced equipment, technology and talents. Integrate resources, give full play to advantages, and strive to build "Fangda" into a well-known enterprise in the international hardware industry.

1987-2022

FANGDA HOLDING

35 YEARS OF RAPID DEVELOPMENT

专注五金工具行业35年



为时代而来，为梦想而来，中国五金工具行业的领跑者，方大三十五年励精图治，在曲折中奋进，在创新中发展，勇于接受品质的挑战，成为行业的引领者和创新典范。

至此三十五年沉淀，时光的细心雕琢，五金行业技术的进步历史，我们是零距离的见证人。研发创新安全通达，我们是全方位的守护神。

12万平米生产制造基地，先进的设备是跨越的奠基石。方大砥砺前行，三十五年铸百年基业，造就五金工具行业的风向标！

诚信为本，赢得客户口碑。感恩回报，达者兼营天下！潮涌催人进，风正好扬帆。

创世界名牌，建百年方大。数十年如一日，方大一直在努力，在梦想的感召中前进！

Rising from the times and dreams, Fangda has been making great efforts for 35 years as a leader in the Chinese hardware industry, advancing in twists and turns, developing in innovation and embracing quality challenges bravely, thus becoming an industrial leader an innovation model.

with a history of 35 years, we're the zero-distance witness of the technological progress history of the hardware history carefully crafted by the time. As a total patrons saint, we develop innovative and safe access solutions.

Our 120,000m² manufacturing base with advanced equipment is the cornerstone of our leap-forward development. Advancing through hardships, Fangda has taken 35 years only to build a century-old foundation and make a benchmark in the hardware tool industry!

Win customer reputation with credit. One who knows thanksgiving and give-away can rule the world! GO ahead as driven by the waves, and hoist your sail when the wind is fair.

Create a world-famous brand and build a century-old Fangda. For decades Fangda has all along been working hard and going ahead in answer to the call of dreams!





CARBIDE TIPPED MASONRY DRILL BITS

Employing high quality alloy steel for drilling body and YG carbide alloy for drilling tip, and in combination with various types of electric hammer. The drill is one of the most efficient tools suitably and widely used for hole drilling in hard materials like concrete/brick in construction & installation industries.

FANGDAWANG HOLDING

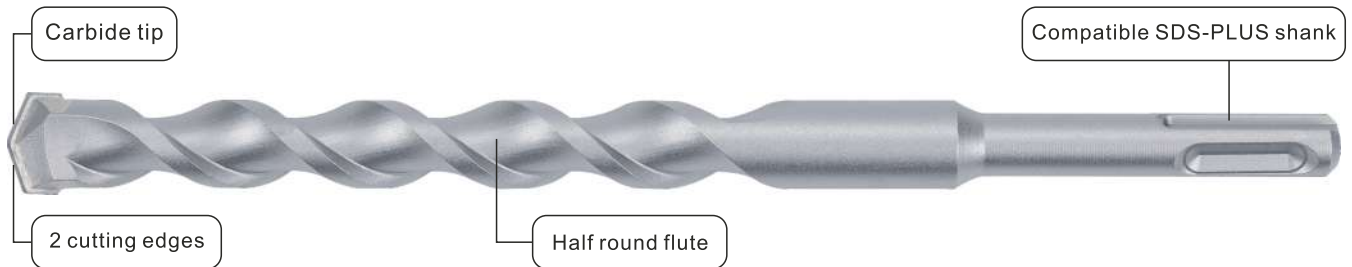
FD-PLUS-1 HAMMER DRILL BIT, Half round flute, Dual cutter

*:MOQ required.
 If special size required, please contact our business department.

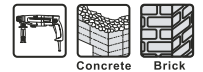

Part No.	Size(mm)	Part No.	Size(mm)	Part No.	Size(mm)
AP01-001*	3.2x90	AP01-038	10x160	AP01-075	14x260
AP01-002*	3.5x110	AP01-039	10x210	AP01-076	14x310
AP01-003*	4x110	AP01-040	10x260	AP01-077	14x350
AP01-004	4x160	AP01-041	10x310	AP01-078*	14x400
AP01-005	5x110	AP01-042	10x350	AP01-079	14x460
AP01-006	5x160	AP01-043*	10x400	AP01-080	14x600
AP01-007	5.5x110	AP01-044	10x460	AP01-081	14x800
AP01-008	5.5x160	AP01-045	10x600	AP01-082	14x1000
AP01-009	5.5x210	AP01-046*	10x800	AP01-083*	15x160
AP01-010	6x110	AP01-047	10x1000	AP01-084*	15x210
AP01-011	6x160	AP01-048*	11x160	AP01-085*	15x260
AP01-012	6x210	AP01-049*	11x210	AP01-086*	15x310
AP01-013	6x260	AP01-050*	11x260	AP01-087*	15x350
AP01-014	6x350	AP01-051*	11x310	AP01-088	15x460
AP01-015	6.5x110	AP01-052*	11x350	AP01-089	16x160
AP01-016	6.5x160	AP01-053*	11x460	AP01-090	16x210
AP01-017	6.5x210	AP01-054*	11x600	AP01-091	16x260
AP01-018	6.5x260	AP01-055*	12x110	AP01-092	16x310
AP01-019*	7x110	AP01-056	12x160	AP01-093	16x350
AP01-020	7x160	AP01-057	12x210	AP01-094*	16x400
AP01-021*	7x210	AP01-058	12x260	AP01-095	16x460
AP01-022	7x260	AP01-059	12x310	AP01-096	16x600
AP01-023	8x110	AP01-060	12x350	AP01-097*	16x800
AP01-024	8x160	AP01-061*	12x400	AP01-098	16x1000
AP01-025	8x210	AP01-062	12x460	AP01-099*	17x210
AP01-026	8x260	AP01-063	12x600	AP01-100*	17x260
AP01-027	8x310	AP01-064*	12x800	AP01-101*	17x310
AP01-028	8x350	AP01-065	12x1000	AP01-102*	17x350
AP01-029*	8x400	AP01-066*	13x160	AP01-103*	17x460
AP01-030	8x460	AP01-067*	13x210	AP01-104	18x210
AP01-031*	9x110	AP01-068*	13x260	AP01-105	18x260
AP01-032	9x160	AP01-069*	13x310	AP01-106	18x310
AP01-033	9x210	AP01-070*	13x350	AP01-107	18x350
AP01-034	9x260	AP01-071*	13x460	AP01-108*	18x400
AP01-035	9x310	AP01-072*	13x600	AP01-109	18x460
AP01-036	9x350	AP01-073	14x160	AP01-110	18x600
AP01-037	10x110	AP01-074	14x210	AP01-111*	18x800

CARBIDE TIPPED MASONRY DRILL BITS



FD-PLUS-2 HAMMER DRILL BIT, W flute, Dual cutter

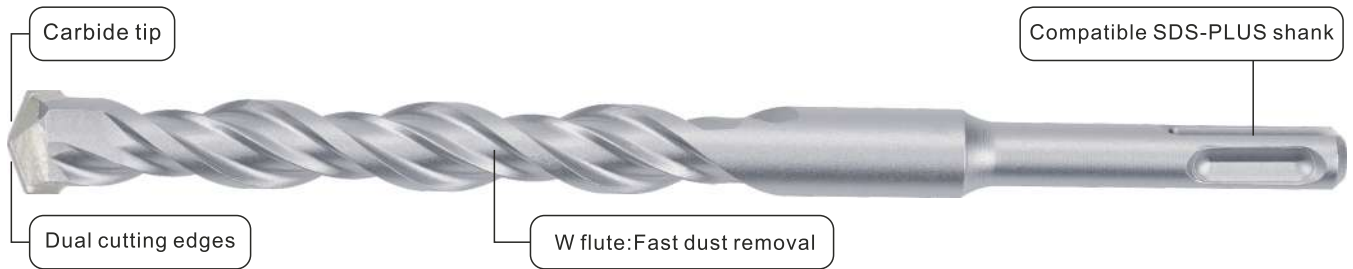

* :MOQ required.

If special size required, please contact our business department.

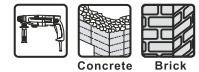

Part No.	Size(mm)	Part No.	Size(mm)	Part No.	Size(mm)
AP02-001*	3.5x110	AP02-038*	9x350	AP02-075	14x160
AP02-002	4x110	AP02-039	10x110	AP02-076	14x210
AP02-003	4x160	AP02-040	10x160	AP02-077	14x260
AP02-004	5x110	AP02-041	10x210	AP02-078	14x310
AP02-005	5x160	AP02-042	10x260	AP02-079	14x350
AP02-006	5x210	AP02-043	10x310	AP02-080*	14x400
AP02-007	5.5x110	AP02-044	10x350	AP02-081	14x460
AP02-008	5.5x160	AP02-045*	10x400	AP02-082	14x600
AP02-009*	5.5x210	AP02-046	10x460	AP02-083	14x800
AP02-010	6x110	AP02-047	10x600	AP02-084	14x1000
AP02-011	6x160	AP02-048	10x800	AP02-085	15x160
AP02-012	6x210	AP02-049	10x1000	AP02-086	15x210
AP02-013	6x260	AP02-050	11x160	AP02-087*	15x260
AP02-014	6x350	AP02-051	11x210	AP02-088*	15x310
AP02-015	6.5x110	AP02-052*	11x260	AP02-089*	15x350
AP02-016	6.5x160	AP02-053*	11x310	AP02-090*	15x460
AP02-017	6.5x210	AP02-054*	11x350	AP02-091	16x160
AP02-018	6.5x260	AP02-055*	11x460	AP02-092	16x210
AP02-019	7x110	AP02-056*	11x600	AP02-093	16x260
AP02-020	7x160	AP02-057	12x110	AP02-094	16x310
AP02-021*	7x210	AP02-058	12x160	AP02-095	16x350
AP02-022*	7x260	AP02-059	12x210	AP02-096*	16x400
AP02-023*	7x310	AP02-060	12x260	AP02-097	16x460
AP02-024*	7x350	AP02-061	12x310	AP02-098	16x600
AP02-025	8x110	AP02-062	12x350	AP02-099	16x800
AP02-026	8x160	AP02-063*	12x400	AP02-100	16x1000
AP02-027	8x210	AP02-064	12x460	AP02-101*	17x210
AP02-028	8x260	AP02-065	12x600	AP02-102*	17x260
AP02-029	8x310	AP02-066	12x800	AP02-103*	17x310
AP02-030	8x350	AP02-067	12x1000	AP02-104*	17x350
AP02-031*	8x400	AP02-068	13x160	AP02-105*	17x460
AP02-032	8x460	AP02-069	13x210	AP02-106	18x160
AP02-033*	9x110	AP02-070	13x260	AP02-107	18x210
AP02-034	9x160	AP02-071*	13x310	AP02-108	18x260
AP02-035	9x210	AP02-072*	13x350	AP02-109	18x310
AP02-036*	9x260	AP02-073*	13x460	AP02-110	18x350
AP02-037*	9x310	AP02-074*	13x600	AP02-111*	18x400

FD-PLUS-3 HAMMER DRILL BIT, W flute, W cutter

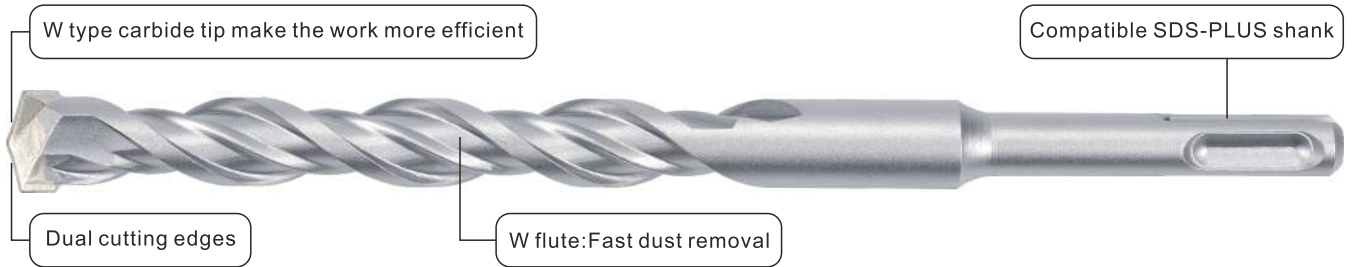

*:MOQ required.
If special size required, please contact our business department.

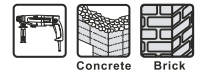

Part No.	Size(mm)	Part No.	Size(mm)	Part No.	Size(mm)
AP03-001	4x110	AP03-038	10x110	AP03-075	14x210
AP03-002	4x160	AP03-039	10x160	AP03-076	14x260
AP03-003	5x110	AP03-040	10x210	AP03-077	14x310
AP03-004	5x160	AP03-041	10x260	AP03-078	14x350
AP03-005	5x210	AP03-042	10x310	AP03-079*	14x400
AP03-006*	5.5x110	AP03-043	10x350	AP03-080	14x460
AP03-007*	5.5x160	AP03-044*	10x400	AP03-081	14x600
AP03-008*	5.5x210	AP03-045	10x460	AP03-082	14x800
AP03-009	6x110	AP03-046	10x600	AP03-083	14x1000
AP03-010	6x160	AP03-047	10x800	AP03-084	15x160
AP03-011	6x210	AP03-048	10x1000	AP03-085	15x210
AP03-012	6x260	AP03-049*	11x160	AP03-086*	15x260
AP03-013	6x350	AP03-050*	11x210	AP03-087*	15x310
AP03-014	6.5x110	AP03-051*	11x260	AP03-088*	15x350
AP03-015	6.5x160	AP03-052*	11x310	AP03-089*	15x460
AP03-016	6.5x210	AP03-053*	11x350	AP03-090	16x160
AP03-017	6.5x260	AP03-054*	11x460	AP03-091	16x210
AP03-018	7x110	AP03-055*	11x600	AP03-092	16x260
AP03-019	7x160	AP03-056	12x110	AP03-093	16x310
AP03-020*	7x210	AP03-057	12x160	AP03-094	16x350
AP03-021*	7x260	AP03-058	12x210	AP03-095*	16x400
AP03-022*	7x310	AP03-059	12x260	AP03-096	16x460
AP03-023*	7x350	AP03-060	12x310	AP03-097	16x600
AP03-024	8x110	AP03-061	12x350	AP03-098	16x800
AP03-025	8x160	AP03-062*	12x400	AP03-099	16x1000
AP03-026	8x210	AP03-063	12x460	AP03-100*	17x210
AP03-027	8x260	AP03-064	12x600	AP03-101*	17x260
AP03-028	8x310	AP03-065	12x800	AP03-102*	17x310
AP03-029	8x350	AP03-066	12x1000	AP03-103*	17x350
AP03-030*	8x400	AP03-067	13x160	AP03-104*	17x460
AP03-031	8x460	AP03-068	13x210	AP03-105	18x160
AP03-032*	9x110	AP03-069	13x260	AP03-106	18x210
AP03-033*	9x160	AP03-070*	13x310	AP03-107	18x260
AP03-034*	9x210	AP03-071*	13x350	AP03-108	18x310
AP03-035*	9x260	AP03-072*	13x460	AP03-109	18x350
AP03-036*	9x310	AP03-073*	13x600	AP03-110*	18x400
AP03-037*	9x350	AP03-074	14x160	AP03-111	18x460

FD-PLUS-4 HAMMER DRILL BIT, LD flute, W cutter



*:MOQ required.
If special size required, please contact our business department.



Part No.	Size(mm)	Part No.	Size(mm)	Part No.	Size(mm)
AP04-001	4x110	AP04-038	10x110	AP04-075	14x210
AP04-002	4x160	AP04-039	10x160	AP04-076	14x260
AP04-003	5x110	AP04-040	10x210	AP04-077	14x310
AP04-004	5x160	AP04-041	10x260	AP04-078	14x350
AP04-005	5x210	AP04-042	10x310	AP04-079*	14x400
AP04-006	5.5x110	AP04-043	10x350	AP04-080	14x460
AP04-007	5.5x160	AP04-044*	10x400	AP04-081	14x600
AP04-008*	5.5x210	AP04-045	10x460	AP04-082	14x800
AP04-009	6x110	AP04-046	10x600	AP04-083	14x1000
AP04-010	6x160	AP04-047	10x800	AP04-084	15x160
AP04-011	6x210	AP04-048	10x1000	AP04-085	15x210
AP04-012	6x260	AP04-049	11x160	AP04-086*	15x260
AP04-013	6x350	AP04-050	11x210	AP04-087*	15x310
AP04-014	6.5x110	AP04-051*	11x260	AP04-088*	15x350
AP04-015	6.5x160	AP04-052*	11x310	AP04-089*	15x460
AP04-016	6.5x210	AP04-053*	11x350	AP04-090	16x160
AP04-017	6.5x260	AP04-054*	11x460	AP04-091	16x210
AP04-018	7x110	AP04-055*	11x600	AP04-092	16x260
AP04-019	7x160	AP04-056	12x110	AP04-093	16x310
AP04-020*	7x210	AP04-057	12x160	AP04-094	16x350
AP04-021*	7x260	AP04-058	12x210	AP04-095*	16x400
AP04-022*	7x310	AP04-059	12x260	AP04-096	16x460
AP04-023*	7x350	AP04-060	12x310	AP04-097	16x600
AP04-024	8x110	AP04-061	12x350	AP04-098	16x800
AP04-025	8x160	AP04-062*	12x400	AP04-099	16x1000
AP04-026	8x210	AP04-063	12x460	AP04-100*	17x210
AP04-027	8x260	AP04-064	12x600	AP04-101*	17x260
AP04-028	8x310	AP04-065	12x800	AP04-102*	17x310
AP04-029	8x350	AP04-066	12x1000	AP04-103*	17x350
AP04-030*	8x400	AP04-067	13x160	AP04-104*	17x460
AP04-031	8x460	AP04-068	13x210	AP04-105	18x160
AP04-032*	9x110	AP04-069	13x260	AP04-106	18x210
AP04-033	9x160	AP04-070*	13x310	AP04-107	18x260
AP04-034	9x210	AP04-071*	13x350	AP04-108	18x310
AP04-035*	9x260	AP04-072*	13x460	AP04-109	18x350
AP04-036*	9x310	AP04-073*	13x600	AP04-110*	18x400
AP04-037*	9x350	AP04-074	14x160	AP04-111	18x460

FD-PLUS-5 HAMMER DRILL BIT, U flute, Self-Centering tip



*:MOQ required.
If special size required, please contact our business department.

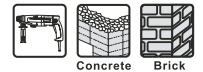

Part No.	Size(mm)	Part No.	Size(mm)	Part No.	Size(mm)
AP05-001	4x110	AP05-038	10x160	AP05-075*	13x600
AP05-002	4x160	AP05-039	10x210	AP05-076*	13x800
AP05-003	5x110	AP05-040	10x260	AP05-077	14x160
AP05-004	5x160	AP05-041	10x310	AP05-078	14x210
AP05-005	5.5x110	AP05-042	10x350	AP05-079	14x260
AP05-006	5.5x160	AP05-043	10x400	AP05-080	14x310
AP05-007	5.5x210	AP05-044	10x460	AP05-081	14x350
AP05-008	6x110	AP05-045	10x600	AP05-082	14x400
AP05-009	6x160	AP05-046	10x800	AP05-083	14x460
AP05-010	6x210	AP05-047	10x1000	AP05-084	14x600
AP05-011	6x260	AP05-048	11x110	AP05-085	14x800
AP05-012	6x350	AP05-049	11x160	AP05-086	14x1000
AP05-013	6.5x110	AP05-050	11x210	AP05-087	15x160
AP05-014	6.5x160	AP05-051*	11x260	AP05-088*	15x210
AP05-015	6.5x210	AP05-052*	11x310	AP05-089*	15x260
AP05-016	6.5x260	AP05-053*	11x350	AP05-090*	15x310
AP05-017	7x110	AP05-054*	11x400	AP05-091*	15x350
AP05-018	7x160	AP05-055*	11x460	AP05-092*	15x400
AP05-019*	7x210	AP05-056*	11x600	AP05-093*	15x460
AP05-020*	7x260	AP05-057	12x110	AP05-094*	15x600
AP05-021	8x110	AP05-058	12x160	AP05-095	16x160
AP05-022	8x160	AP05-059	12x210	AP05-096	16x210
AP05-023	8x210	AP05-060	12x260	AP05-097	16x260
AP05-024	8x260	AP05-061	12x310	AP05-098	16x310
AP05-025	8x310	AP05-062	12x350	AP05-099	16x350
AP05-026	8x350	AP05-063	12x400	AP05-100	16x400
AP05-027	8x400	AP05-064	12x460	AP05-101	16x460
AP05-028	8x460	AP05-065	12x600	AP05-102	16x600
AP05-029	9x110	AP05-066	12x800	AP05-103	16x800
AP05-030	9x160	AP05-067	12x1000	AP05-104	16x1000
AP05-031	9x210	AP05-068	13x160	AP05-105*	17x160
AP05-032*	9x260	AP05-069	13x210	AP05-106*	17x210
AP05-033*	9x310	AP05-070	13x260	AP05-107*	17x260
AP05-034*	9x350	AP05-071	13x310	AP05-108*	17x310
AP05-035*	9x400	AP05-072	13x350	AP05-109*	17x350
AP05-036*	9x460	AP05-073*	13x400	AP05-110*	17x400
AP05-037	10x110	AP05-074*	13x460	AP05-111*	17x460

CARBIDE TIPPED MASONRY DRILL BITS



FD-PLUS-6 HAMMER DRILL BIT, U flute, W cutter, PGM

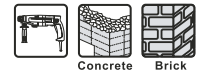
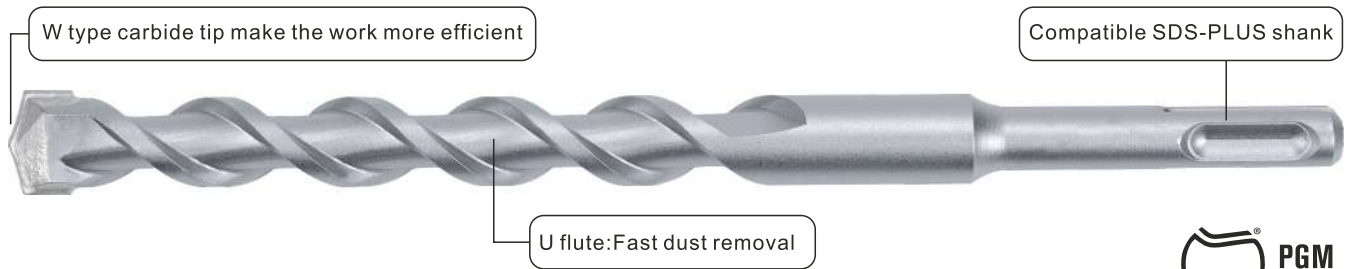

* :MOQ required.
If special size required, please contact our business department.

Part No.	Size(mm)	Part No.	Size(mm)	Part No.	Size(mm)
AP06-001	4x110	AP06-028*	12x360	AP06-055*	18x360
AP06-002	4x160	AP06-029*	12x400	AP06-056*	18x400
AP06-003	5x110	AP06-030	12x460	AP06-057	18x450
AP06-004	5x160	AP06-031	13x160	AP06-058	20x200
AP06-005	6x110	AP06-032	13x210	AP06-059	20x250
AP06-006	6x160	AP06-033	13x260	AP06-060	20x300
AP06-007	6x210	AP06-034	13x310	AP06-061*	20x360
AP06-008	6x260	AP06-035*	13x360	AP06-062*	20x400
AP06-009	8x110	AP06-036*	13x400	AP06-063	20x450
AP06-010	8x160	AP06-037	13x460	AP06-064	22x200
AP06-011	8x210	AP06-038	14x160	AP06-065	22x250
AP06-012	8x260	AP06-039	14x210	AP06-066	22x300
AP06-013	8x310	AP06-040	14x260	AP06-067*	22x360
AP06-014*	8x360	AP06-041	14x310	AP06-068*	22x400
AP06-015*	8x400	AP06-042*	14x360	AP06-069	22x450
AP06-016	8x460	AP06-043*	14x400	AP06-070	24x200
AP06-017	10x160	AP06-044	14x460	AP06-071	24x250
AP06-018	10x210	AP06-045	16x160	AP06-072	24x300
AP06-019	10x260	AP06-046	16x210	AP06-073*	24x360
AP06-020	10x310	AP06-047	16x260	AP06-074*	24x400
AP06-021*	10x360	AP06-048	16x310	AP06-075	24x450
AP06-022*	10x400	AP06-049*	16x360	AP06-076	25x200
AP06-023	10x460	AP06-050*	16x400	AP06-077	25x250
AP06-024	12x160	AP06-051	16x460	AP06-078	25x300
AP06-025	12x210	AP06-052	18x200	AP06-079*	25x360
AP06-026	12x260	AP06-053	18x250	AP06-080*	25x400
AP06-027	12x310	AP06-054	18x300	AP06-081	25x450

FD-PLUS-7 HAMMER DRILL BIT, U flute, 46000



*:MOQ required.
If special size required, please contact our business department.

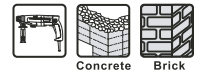

Part No.	Size(mm)	Part No.	Size(mm)	Part No.	Size(mm)
AP07-001	4x110	AP07-038	11x160	AP07-075	16x460
AP07-002	4x160	AP07-039	11x210	AP07-076	16x600
AP07-003	5x110	AP07-040	11x260	AP07-077	17x160
AP07-004	5x160	AP07-041	11x310	AP07-078	17x210
AP07-005	5.5x110	AP07-042	11x350	AP07-079	17x260
AP07-006	5.5x160	AP07-043	12x160	AP07-080	17x310
AP07-007	5.5x210	AP07-044	12x210	AP07-081	17x350
AP07-008	6x110	AP07-045	12x260	AP07-082	17x460
AP07-009	6x160	AP07-046	12x310	AP07-083	17x600
AP07-010	6x210	AP07-047	12x350	AP07-084	18x210
AP07-011	6x260	AP07-048	12x460	AP07-085	18x260
AP07-012	6.5x110	AP07-049	12x600	AP07-086	18x310
AP07-013	6.5x160	AP07-050	13x160	AP07-087	18x350
AP07-014	6.5x210	AP07-051	13x210	AP07-088	18x460
AP07-015	6.5x260	AP07-052	13x260	AP07-089	18x600
AP07-016	7x110	AP07-053	13x310	AP07-090	19x210
AP07-017	7x160	AP07-054	13x350	AP07-091	19x260
AP07-018	7x210	AP07-055	13x460	AP07-092	19x310
AP07-019	7x260	AP07-056	14x160	AP07-093	19x350
AP07-020	8x110	AP07-057	14x210	AP07-094	19x460
AP07-021	8x160	AP07-058	14x260	AP07-095	19x600
AP07-022	8x210	AP07-059	14x310	AP07-096	20x210
AP07-023	8x260	AP07-060	14x350	AP07-097	20x260
AP07-024	8x310	AP07-061	14x460	AP07-098	20x310
AP07-025	8x350	AP07-062	14x600	AP07-099	20x350
AP07-026	8x600	AP07-063	15x160	AP07-100	20x460
AP07-027	9x260	AP07-064	15x210	AP07-101	20x600
AP07-028	9x310	AP07-065	15x260	AP07-102	22x210
AP07-029	9x350	AP07-066	15x310	AP07-103	22x260
AP07-030	10x110	AP07-067	15x350	AP07-104	22x310
AP07-031	10x160	AP07-068	15x460	AP07-105	22x350
AP07-032	10x210	AP07-069	15x600	AP07-106	22x460
AP07-033	10x260	AP07-070	16x160	AP07-107	22x600
AP07-034	10x310	AP07-071	16x210	AP07-108	24x210
AP07-035	10x350	AP07-072	16x260	AP07-109	24x260
AP07-036	10x460	AP07-073	16x310	AP07-110	24x310
AP07-037	10x600	AP07-074	16x350	AP07-111	24x350

FD-PLUS-8 HAMMER DRILL BIT, U flute, 46000, PGM



*:MOQ required.
If special size required, please contact our business department.

Part No.	Size(mm)	Part No.	Size(mm)	Part No.	Size(mm)
AP08-001	4x110	AP08-034	22x210	AP08-067	28x310
AP08-002	5x110	AP08-035	24x210	AP08-068	8x350
AP08-003	6x110	AP08-036	25x210	AP08-069	10x350
AP08-004	7x110	AP08-037	6x260	AP08-070*	11x350
AP08-005	8x110	AP08-038	7x260	AP08-071	12x350
AP08-006	10x110	AP08-039	8x260	AP08-072*	13x350
AP08-007	11x110	AP08-040	10x260	AP08-073	14x350
AP08-008	12x110	AP08-041*	11x260	AP08-074*	15x350
AP08-009	4x160	AP08-042	12x260	AP08-075	16x350
AP08-010	5x160	AP08-043*	13x260	AP08-076	18x350
AP08-011	6x160	AP08-044	14x260	AP08-077*	19x350
AP08-012	7x160	AP08-045*	15x260	AP08-078	20x350
AP08-013	8x160	AP08-046	16x260	AP08-079	22x350
AP08-014	10x160	AP08-047	18x260	AP08-080	24x350
AP08-015	11x160	AP08-048*	19x260	AP08-081	25x350
AP08-016	12x160	AP08-049	20x260	AP08-082	28x350
AP08-017*	13x160	AP08-050	22x260	AP08-084	8x460
AP08-018	14x160	AP08-051	24x260	AP08-085	10x460
AP08-019*	15x160	AP08-052	25x260	AP08-086*	11x460
AP08-020	16x160	AP08-053	8x310	AP08-087	12x460
AP08-021	6x210	AP08-054	10x310	AP08-088*	13x460
AP08-022	7x210	AP08-055*	11x310	AP08-089	14x460
AP08-023	8x210	AP08-056	12x310	AP08-090*	15x460
AP08-024	10x210	AP08-057*	13x310	AP08-091	16x460
AP08-025*	11x210	AP08-058	14x310	AP08-092	18x460
AP08-026	12x210	AP08-059*	15x310	AP08-093*	19x460
AP08-027*	13x210	AP08-060	16x310	AP08-094	20x460
AP08-028	14x210	AP08-061	18x310	AP08-083	22x460
AP08-029*	15x210	AP08-062*	19x310	AP08-095	24x460
AP08-030	16x210	AP08-063	20x310	AP08-096	25x460
AP08-031	18x210	AP08-064	22x310	AP08-097	28x460
AP08-032*	19x210	AP08-065	24x310	AP08-098	30x460
AP08-033	20x210	AP08-066	25x310		

FD-PLUS-9 HAMMER DRILL BIT, Half round flute, 4 cutter

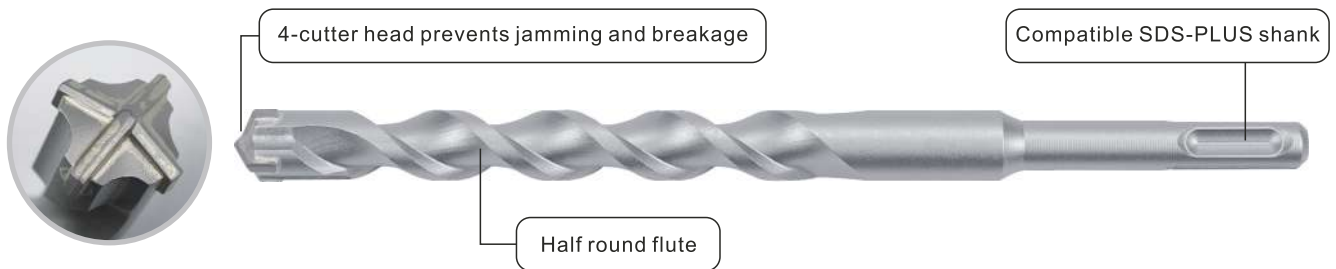

*:MOQ required.
If special size required, please contact our business department.

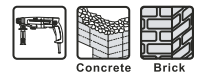

Part No.	Size(mm)	Part No.	Size(mm)	Part No.	Size(mm)
AP09-001	6x110	AP09-038*	10x800	AP09-075*	15x160
AP09-002	6x160	AP09-039	10x1000	AP09-076*	15x210
AP09-003	6x210	AP09-040*	11x160	AP09-077*	15x260
AP09-004	6x260	AP09-041*	11x210	AP09-078*	15x310
AP09-005	6x350	AP09-042*	11x260	AP09-079*	15x350
AP09-006	6.5x110	AP09-043*	11x310	AP09-080	15x460
AP09-007	6.5x160	AP09-044*	11x350	AP09-081	16x160
AP09-008	6.5x210	AP09-045*	11x460	AP09-082	16x210
AP09-009	6.5x260	AP09-046*	11x600	AP09-083	16x260
AP09-010*	7x110	AP09-047*	12x110	AP09-084	16x310
AP09-011	7x160	AP09-048	12x160	AP09-085	16x350
AP09-012*	7x210	AP09-049	12x210	AP09-086*	16x400
AP09-013	7x260	AP09-050	12x260	AP09-087	16x460
AP09-014	8x110	AP09-051	12x310	AP09-088	16x600
AP09-015	8x160	AP09-052	12x350	AP09-089*	16x800
AP09-016	8x210	AP09-053*	12x400	AP09-090	16x1000
AP09-017	8x260	AP09-054	12x460	AP09-091*	17x210
AP09-018	8x310	AP09-055	12x600	AP09-092*	17x260
AP09-019	8x350	AP09-056*	12x800	AP09-093*	17x310
AP09-020*	8x400	AP09-057	12x1000	AP09-094*	17x350
AP09-021	8x460	AP09-058*	13x160	AP09-095*	17x460
AP09-022*	9x110	AP09-059*	13x210	AP09-096	18x210
AP09-023	9x160	AP09-060*	13x260	AP09-097	18x260
AP09-024	9x210	AP09-061*	13x310	AP09-098	18x310
AP09-025	9x260	AP09-062*	13x350	AP09-099	18x350
AP09-026	9x310	AP09-063*	13x460	AP09-100*	18x400
AP09-027	9x350	AP09-064*	13x600	AP09-101	18x460
AP09-028	9x460	AP09-065	14x160	AP09-102	18x600
AP09-029	10x110	AP09-066	14x210	AP09-103*	18x800
AP09-030	10x160	AP09-067	14x260	AP09-104	18x1000
AP09-031	10x210	AP09-068	14x310	AP09-105*	19x210
AP09-032	10x260	AP09-069	14x350	AP09-106*	19x260
AP09-033	10x310	AP09-070*	14x400	AP09-107*	19x310
AP09-034	10x350	AP09-071	14x460	AP09-108*	19x350
		AP09-072	14x600		
AP09-036	10x460	AP09-073	14x800	AP09-110	20x210
AP09-037	10x600	AP09-074	14x1000	AP09-111	20x260

FD-PLUS-10 HAMMER DRILL BIT, 4 flute, 4 cutter

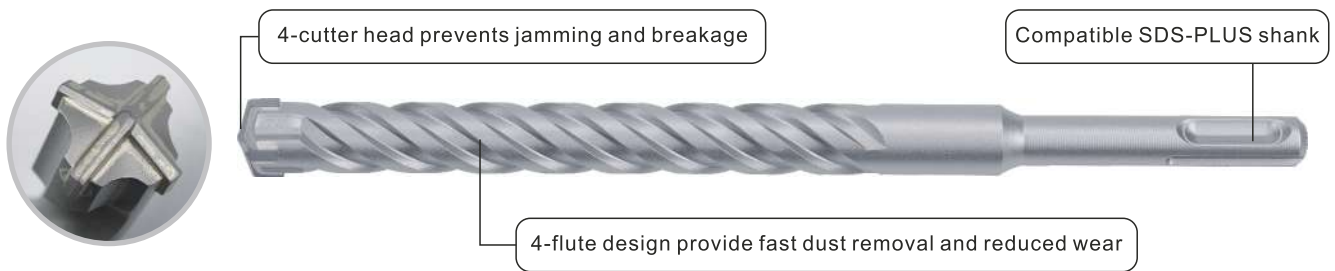

*:MOQ required.

If special size required, please contact our business department.

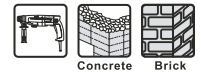

Part No.	Size(mm)	Part No.	Size(mm)	Part No.	Size(mm)
AP10-001	6x110	AP10-038*	10x800	AP10-075*	15x160
AP10-002	6x160	AP10-039	10x1000	AP10-076*	15x210
AP10-003	6x210	AP10-040*	11x160	AP10-077*	15x260
AP10-004	6x260	AP10-041*	11x210	AP10-078*	15x310
AP10-005	6x350	AP10-042*	11x260	AP10-079*	15x350
AP10-006	6.5x110	AP10-043*	11x310	AP10-080	15x460
AP10-007	6.5x160	AP10-044*	11x350	AP10-081	16x160
AP10-008	6.5x210	AP10-045*	11x460	AP10-082	16x210
AP10-009	6.5x260	AP10-046*	11x600	AP10-083	16x260
AP10-010*	7x110	AP10-047*	12x110	AP10-084	16x310
AP10-011	7x160	AP10-048	12x160	AP10-085	16x350
AP10-012*	7x210	AP10-049	12x210	AP10-086*	16x400
AP10-013	7x260	AP10-050	12x260	AP10-087	16x460
AP10-014	8x110	AP10-051	12x310	AP10-088	16x600
AP10-015	8x160	AP10-052	12x350	AP10-089*	16x800
AP10-016	8x210	AP10-053*	12x400	AP10-090	16x1000
AP10-017	8x260	AP10-054	12x460	AP10-091*	17x210
AP10-018	8x310	AP10-055	12x600	AP10-092*	17x260
AP10-019	8x350	AP10-056*	12x800	AP10-093*	17x310
AP10-020*	8x400	AP10-057	12x1000	AP10-094*	17x350
AP10-021	8x460	AP10-058*	13x160	AP10-095*	17x460
AP10-022*	9x110	AP10-059*	13x210	AP10-096	18x210
AP10-023	9x160	AP10-060*	13x260	AP10-097	18x260
AP10-024	9x210	AP10-061*	13x310	AP10-098	18x310
AP10-025	9x260	AP10-062*	13x350	AP10-099	18x350
AP10-026	9x310	AP10-063*	13x460	AP10-100*	18x400
AP10-027	9x350	AP10-064*	13x600	AP10-101	18x460
AP10-028	9x460	AP10-065	14x160	AP10-102	18x600
AP10-029	10x110	AP10-066	14x210	AP10-103*	18x800
AP10-030	10x160	AP10-067	14x260	AP10-104	18x1000
AP10-031	10x210	AP10-068	14x310	AP10-105*	19x210
AP10-032	10x260	AP10-069	14x350	AP10-106*	19x260
AP10-033	10x310	AP10-070*	14x400	AP10-107*	19x310
AP10-034	10x350	AP10-071	14x460	AP10-108*	19x350
AP10-035*	10x400	AP10-072	14x600	AP10-109*	19x460
AP10-036	10x460	AP10-073	14x800	AP10-110	20x210
AP10-037	10x600	AP10-074	14x1000	AP10-111	20x260

FD-PLUS-11 HAMMER DRILL BIT, W flute, 4 cutter

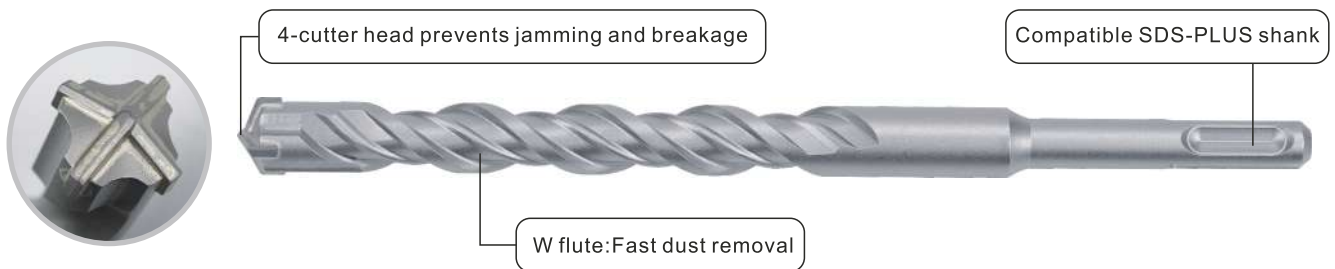

*:MOQ required.
If special size required, please contact our business department.



Part No.	Size(mm)	Part No.	Size(mm)	Part No.	Size(mm)
AP11-001	6x110	AP11-038*	10x800	AP11-075*	15x160
AP11-002	6x160	AP11-039	10x1000	AP11-076*	15x210
AP11-003	6x210	AP11-040*	11x160	AP11-077*	15x260
AP11-004	6x260	AP11-041*	11x210	AP11-078*	15x310
AP11-005	6x350	AP11-042*	11x260	AP11-079*	15x350
AP11-006	6.5x110	AP11-043*	11x310	AP11-080	15x460
AP11-007	6.5x160	AP11-044*	11x350	AP11-081	16x160
AP11-008	6.5x210	AP11-045*	11x460	AP11-082	16x210
AP11-009	6.5x260	AP11-046*	11x600	AP11-083	16x260
AP11-010*	7x110	AP11-047*	12x110	AP11-084	16x310
AP11-011	7x160	AP11-048	12x160	AP11-085	16x350
AP11-012*	7x210	AP11-049	12x210	AP11-086*	16x400
AP11-013	7x260	AP11-050	12x260	AP11-087	16x460
AP11-014	8x110	AP11-051	12x310	AP11-088	16x600
AP11-015	8x160	AP11-052	12x350	AP11-089*	16x800
AP11-016	8x210	AP11-053*	12x400	AP11-090	16x1000
AP11-017	8x260	AP11-054	12x460	AP11-091*	17x210
AP11-018	8x310	AP11-055	12x600	AP11-092*	17x260
AP11-019	8x350	AP11-056*	12x800	AP11-093*	17x310
AP11-020*	8x400	AP11-057	12x1000	AP11-094*	17x350
AP11-021	8x460	AP11-058*	13x160	AP11-095*	17x460
AP11-022*	9x110	AP11-059*	13x210	AP11-096	18x210
AP11-023	9x160	AP11-060*	13x260	AP11-097	18x260
AP11-024	9x210	AP11-061*	13x310	AP11-098	18x310
AP11-025	9x260	AP11-062*	13x350	AP11-099	18x350
AP11-026	9x310	AP11-063*	13x460	AP11-100*	18x400
AP11-027	9x350	AP11-064*	13x600	AP11-101	18x460
AP11-028	9x460	AP11-065	14x160	AP11-102	18x600
AP11-029	10x110	AP11-066	14x210	AP11-103*	18x800
AP11-030	10x160	AP11-067	14x260	AP11-104	18x1000
AP11-031	10x210	AP11-068	14x310	AP11-105*	19x210
AP11-032	10x260	AP11-069	14x350	AP11-106*	19x260
AP11-033	10x310	AP11-070*	14x400	AP11-107*	19x310
AP11-034	10x350	AP11-071	14x460	AP11-108*	19x350
AP11-035*	10x400	AP11-072	14x600	AP11-109*	19x460
AP11-036	10x460	AP11-073	14x800	AP11-110	20x210
AP11-037	10x600	AP11-074	14x1000	AP11-111	20x260

CARBIDE TIPPED MASONRY DRILL BITS



FD-PLUS-12 HAMMER DRILL BIT, U flute, CT4

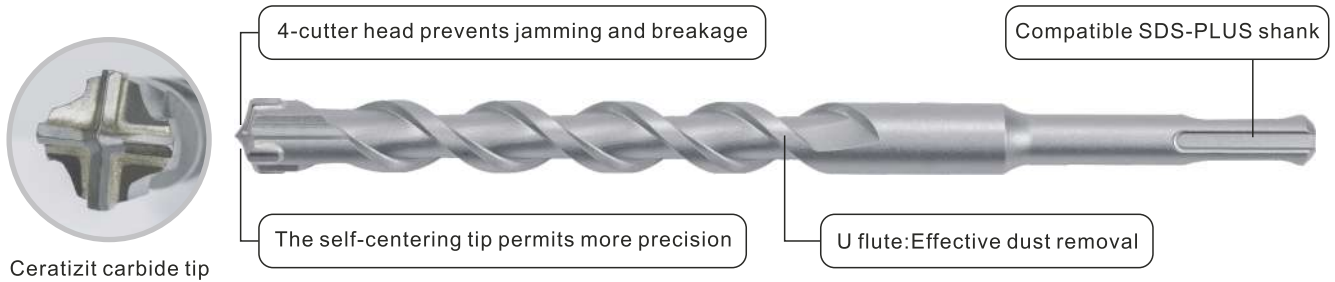

*:MOQ required.
If special size required, please contact our business department.

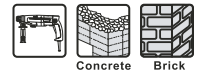

Part No.	Size(mm)	Part No.	Size(mm)	Part No.	Size(mm)
AP12-001	5x110	AP12-016	8x210	AP12-031	12x350
AP12-002	5x160	AP12-017	8x260	AP12-032	12x460
AP12-003	6x110	AP12-018	8x310	AP12-033	14x160
AP12-004	6x160	AP12-019	8x460	AP12-034	14x210
AP12-005	6x210	AP12-020	10x110	AP12-035	14x260
AP12-006	6x260	AP12-021	10x160	AP12-036	14x310
AP12-007	6.5x110	AP12-022	10x210	AP12-037	14x350
AP12-008	6.5x160	AP12-023	10x260	AP12-038	14x460
AP12-009	6.5x210	AP12-024	10x310	AP12-039	16x160
AP12-010	6.5x260	AP12-025	10x350	AP12-040	16x210
AP12-011*	7x110	AP12-026	10x460	AP12-041	16x260
AP12-012	7x160	AP12-027	12x160	AP12-042	16x310
AP12-013*	7x210	AP12-028	12x210	AP12-043	16x350
AP12-014	8x110	AP12-029	12x260	AP12-044	16x460
AP12-015	8x160	AP12-030	12x310		

FD-MAX-5 HAMMER DRILL BIT, U flute, CT4

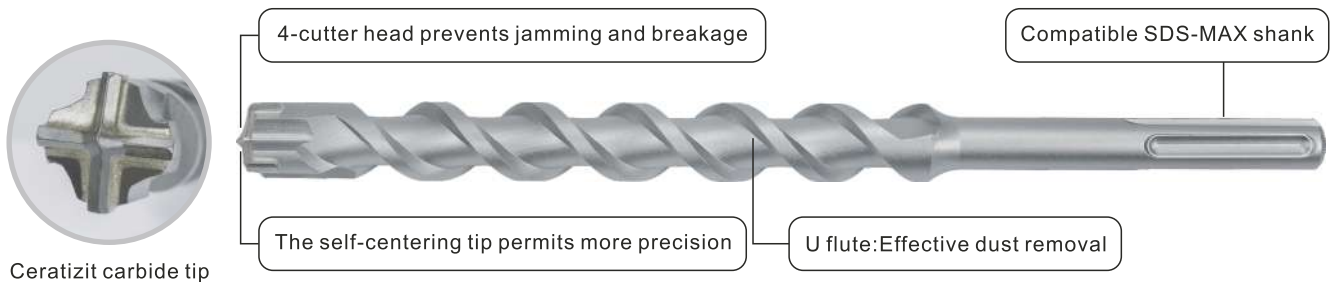

*:MOQ required.
If special size required, please contact our business department.

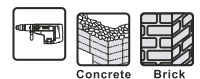

Part No.	Size(mm)	Part No.	Size(mm)	Part No.	Size(mm)
AM05-001	12x340	AM05-007	18x340	AM05-013	25x340
AM05-002	12x540	AM05-008	18x540	AM05-014	25x540
AM05-003	14x340	AM05-009	20x340	AM05-015	28x370
AM05-004	14x540	AM05-010	20x540	AM05-016	28x570
AM05-005	16x340	AM05-011	22x340	AM05-017	30x370
AM05-006	16x540	AM05-012	22x540	AM05-018	30x570

FD-MAX-1 HAMMER DRILL BIT, Half round flute, Dual cutter

*:MOQ required.
If special size required, please contact our business department.

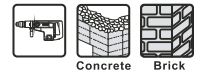

Part No.	Size(mm)	Part No.	Size(mm)	Part No.	Size(mm)
AM01-001*	10x260	AM01-035	20x340	AM01-069*	30x505
AM01-002	10x340	AM01-036*	20x400	AM01-070	30x540
AM01-003	10x540	AM01-037	20x540	AM01-071	30x600
AM01-004	10x600	AM01-038	20x600	AM01-072	30x670
AM01-005	12x260	AM01-039	20x670	AM01-073	30x800
AM01-006	12x340	AM01-040	20x800	AM01-074	30x1000
AM01-007	12x540	AM01-041	20x1000	AM01-075*	32x340
AM01-008	12x600	AM01-042	22x260	AM01-076	32x540
AM01-009	14x260	AM01-043	22x340	AM01-077	32x600
AM01-010	14x340	AM01-044*	22x400	AM01-078	32x800
AM01-011*	14x400	AM01-045	22x505	AM01-079	32x1000
AM01-012	14x540	AM01-046	22x540	AM01-080	35x540
AM01-013	14x600	AM01-047	22x600	AM01-081	35x600
AM01-014	14x670	AM01-048	22x670	AM01-082	35x670
AM01-015	14x1000	AM01-049	22x800	AM01-083	35x800
AM01-016	16x260	AM01-050	22x1000	AM01-084	35x1000
AM01-017	16x340	AM01-051	25x260	AM01-085*	38x400
AM01-018*	16x400	AM01-052	25x340	AM01-086	38x540
AM01-019	16x505	AM01-053*	25x400	AM01-087	38x600
AM01-020	16x540	AM01-054	25x505	AM01-088	38x800
AM01-021	16x600	AM01-055	25x540	AM01-089	38x1000
AM01-022	16x670	AM01-056	25x600	AM01-090	40x540
AM01-023	16x800	AM01-057	25x800	AM01-091	40x600
AM01-024	16x1000	AM01-058	25x1000	AM01-092	40x670
AM01-025	18x260	AM01-059	28x340	AM01-093	40x800
AM01-026	18x340	AM01-060*	28x400	AM01-094	40x1000
AM01-027*	18x400	AM01-061	28x505	AM01-095	42x570
AM01-028	18x505	AM01-062	28x540	AM01-096	42x600
AM01-029	18x540	AM01-063	28x600	AM01-097	42x800
AM01-030	18x600	AM01-064	28x670	AM01-098	42x1000
AM01-031	18x670	AM01-065	28x800	AM01-099	45x540
AM01-032	18x800	AM01-066	28x1000	AM01-100	45x1000
AM01-033	18x1000	AM01-067	30x340	AM01-101	52x540
AM01-034	20x260	AM01-068*	30x400	AM01-102	52x1000

FD-MAX-2 HAMMER DRILL BIT, U flute, Dual cutter

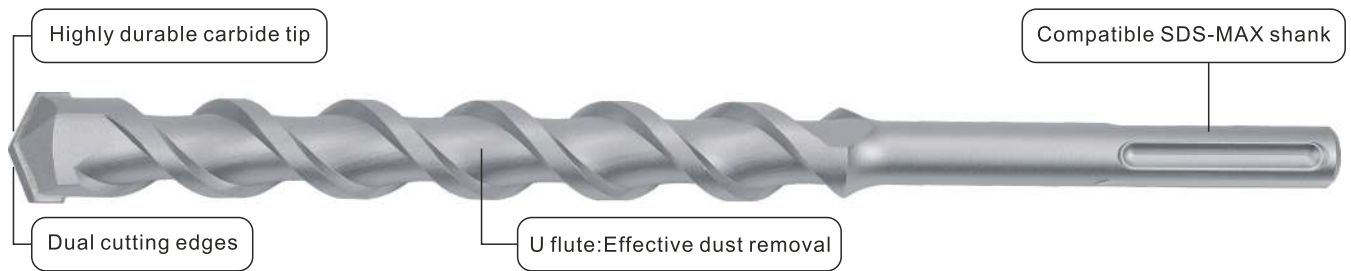

* :MOQ required.
If special size required, please contact our business department.

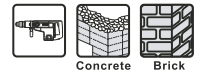

Part No.	Size(mm)	Part No.	Size(mm)	Part No.	Size(mm)
AM02-001	12x340	AM02-017	22x540	AM02-033*	32x1000
AM02-002	12x540	AM02-018*	22x1000	AM02-034	35x370
AM02-003	14x340	AM02-019	24x340	AM02-035	35x570
AM02-004	14x540	AM02-020	24x540	AM02-036*	35x1000
AM02-005*	15x340	AM02-021*	24x1000	AM02-037	38x370
AM02-006*	15x540	AM02-022	25x340	AM02-038	38x570
AM02-007	16x340	AM02-023	25x540	AM02-039*	38x1000
AM02-008	16x540	AM02-024*	25x1000	AM02-040	40x370
AM02-009*	16x1000	AM02-025	28x370	AM02-041	40x570
AM02-010	18x340	AM02-026	28x570	AM02-042*	40x1000
AM02-011	18x540	AM02-027*	28x1000	AM02-043	45x540
AM02-012*	18x1000	AM02-028	30x370	AM02-044	45x1000
AM02-013	20x340	AM02-029	30x570	AM02-045	52x540
AM02-014	20x540	AM02-030*	30x1000	AM02-046	52x1000
AM02-015*	20x1000	AM02-031	32x370		
AM02-016	22x340	AM02-032	32x570		



FD-MAX-3 HAMMER DRILL BIT, Half round flute, 4 cutter

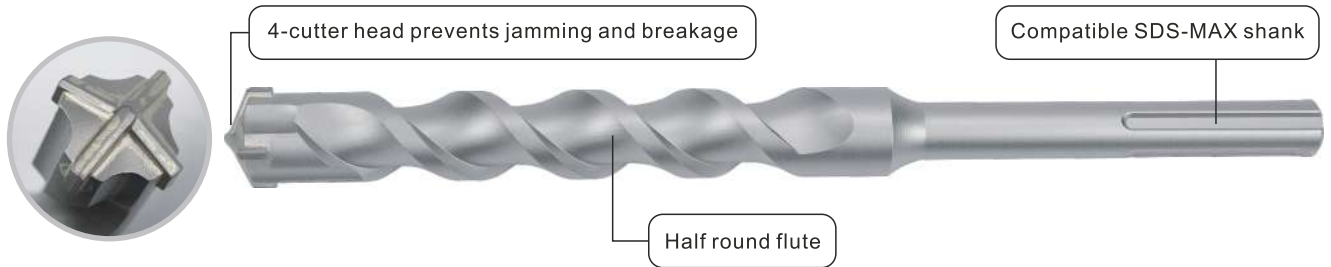

*:MOQ required.
If special size required, please contact our business department.

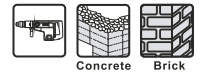

Part No.	Size(mm)	Part No.	Size(mm)	Part No.	Size(mm)
AM03-001*	10x260	AM03-035*	20x400	AM03-069	30x540
AM03-002	10x340	AM03-036	20x540	AM03-070	30x600
AM03-003	10x540	AM03-037	20x600	AM03-071	30x670
AM03-004	10x600	AM03-038	20x670	AM03-072	30x800
AM03-005	12x260	AM03-039	20x800	AM03-073	30x1000
AM03-006	12x340	AM03-040	20x1000	AM03-074*	32x340
AM03-007	12x540	AM03-041	22x260	AM03-075	32x540
AM03-008	12x600	AM03-042	22x340	AM03-076	32x600
AM03-009	14x260	AM03-043*	22x400	AM03-077	32x800
AM03-010	14x340	AM03-044	22x505	AM03-078	32x1000
AM03-011*	14x400	AM03-045	22x540	AM03-079	35x540
AM03-012	14x540	AM03-046	22x600	AM03-080	35x600
AM03-013	14x600	AM03-047	22x670	AM03-081	35x670
AM03-014	14x670	AM03-048	22x800	AM03-082	35x800
AM03-015	14x1000	AM03-049	22x1000	AM03-083	35x1000
AM03-016	16x260	AM03-050	25x260	AM03-084*	38x400
AM03-017	16x340	AM03-051	25x340	AM03-085	38x600
AM03-018	16x505	AM03-052*	25x400	AM03-086	38x800
AM03-019	16x540	AM03-053	25x505	AM03-087	38x1000
AM03-020	16x600	AM03-054	25x540	AM03-088	40x540
AM03-021	16x670	AM03-055	25x600	AM03-089	40x600
AM03-022	16x800	AM03-056	25x800	AM03-090	40x670
AM03-023	16x1000	AM03-057	25x1000	AM03-091	40x800
AM03-024	18x260	AM03-058	28x340	AM03-092	40x1000
AM03-025	18x340	AM03-059*	28x400	AM03-093	42x570
AM03-026*	18x400	AM03-060	28x505	AM03-094	42x600
AM03-027	18x505	AM03-061	28x540	AM03-095	42x800
AM03-028	18x540	AM03-062	28x600	AM03-096	42x1000
AM03-029	18x600	AM03-063	28x670	AM03-097	45x540
AM03-030	18x670	AM03-064	28x800	AM03-098	45x1000
AM03-031	18x800	AM03-065	28x1000	AM03-099	52x540
AM03-032	18x1000	AM03-066	30x340	AM03-100	52x1000
AM03-033	20x260	AM03-067*	30x400		
AM03-034	20x340	AM03-068*	30x505		

FD-MAX-4 HAMMER DRILL BIT, W flute, 4 cutter

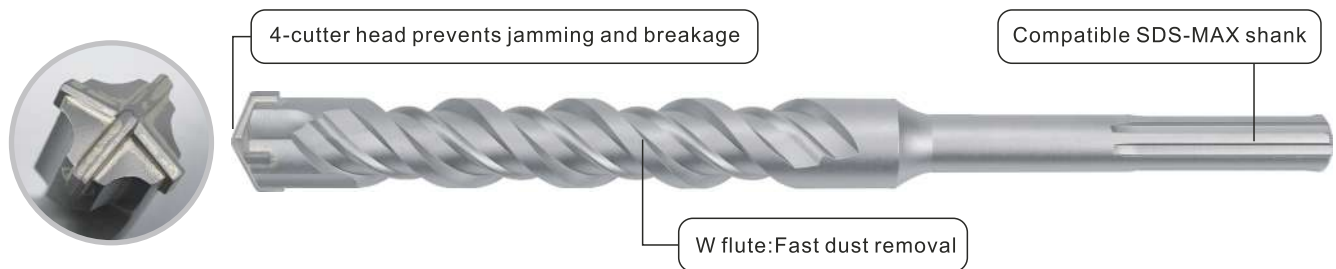

* :MOQ required.
If special size required, please contact our business department.

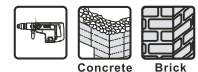

Part No.	Size(mm)	Part No.	Size(mm)	Part No.	Size(mm)
AM04-001*	10x260	AM04-035*	20x400	AM04-069	30x540
AM04-002	10x340	AM04-036	20x540	AM04-070	30x600
AM04-003	10x540	AM04-037	20x600	AM04-071	30x670
AM04-004	10x600	AM04-038	20x670	AM04-072	30x800
AM04-005	12x260	AM04-039	20x800	AM04-073	30x1000
AM04-006	12x340	AM04-040	20x1000	AM04-074*	32x340
AM04-007	12x540	AM04-041	22x260	AM04-075	32x540
AM04-008	12x600	AM04-042	22x340	AM04-076	32x600
AM04-009	14x260	AM04-043*	22x400	AM04-077	32x800
AM04-010	14x340	AM04-044	22x505	AM04-078	32x1000
AM04-011*	14x400	AM04-045	22x540	AM04-079	35x540
AM04-012	14x540	AM04-046	22x600	AM04-080	35x600
AM04-013	14x600	AM04-047	22x670	AM04-081	35x670
AM04-014	14x670	AM04-048	22x800	AM04-082	35x800
AM04-015	14x1000	AM04-049	22x1000	AM04-083	35x1000
AM04-016	16x260	AM04-050	25x260	AM04-084*	38x400
AM04-017	16x340	AM04-051	25x340	AM04-085	38x600
AM04-018	16x505	AM04-052*	25x400	AM04-086	38x800
AM04-019	16x540	AM04-053	25x505	AM04-087	38x1000
AM04-020	16x600	AM04-054	25x540	AM04-088	40x540
AM04-021	16x670	AM04-055	25x600	AM04-089	40x600
AM04-022	16x800	AM04-056	25x800	AM04-090	40x670
AM04-023	16x1000	AM04-057	25x1000	AM04-091	40x800
AM04-024	18x260	AM04-058	28x340	AM04-092	40x1000
AM04-025	18x340	AM04-059*	28x400	AM04-093	42x570
AM04-026*	18x400	AM04-060	28x505	AM04-094	42x600
AM04-027	18x505	AM04-061	28x540	AM04-095	42x800
AM04-028	18x540	AM04-062	28x600	AM04-096	42x1000
AM04-029	18x600	AM04-063	28x670	AM04-097	45x540
AM04-030	18x670	AM04-064	28x800	AM04-098	45x1000
AM04-031	18x800	AM04-065	28x1000	AM04-099	52x540
AM04-032	18x1000	AM04-066	30x340	AM04-100	52x1000
AM04-033	20x260	AM04-067*	30x400		
AM04-034	20x340	AM04-068*	30x505		

FD-HEX-1 HAMMER DRILL BIT, L flute, Dual cutter



*:MOQ required.
If special size required, please contact our business department.

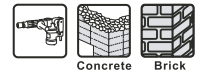

Part No.	Size(mm)	Part No.	Size(mm)	Part No.	Size(mm)
AH01-001	10x280	AH01-014	18x505	AH01-027	25x600
AH01-002*	10x400	AH01-015	18x600	AH01-028*	28x400
AH01-003	12x280	AH01-016	20x280	AH01-029	28x505
AH01-004*	12x400	AH01-017*	20x400	AH01-030	28x600
AH01-005	14x280	AH01-018	20x505	AH01-031	30x505
AH01-006*	14x400	AH01-019	20x600	AH01-032	30x600
AH01-007	14x505	AH01-020	22x280	AH01-033	32x505
AH01-008	16x280	AH01-021*	22x400	AH01-034	32x600
AH01-009*	16x400	AH01-022	22x505	AH01-035	35x505
AH01-010	16x505	AH01-023	22x600	AH01-036	35x600
AH01-011	16x600	AH01-024	25x280	AH01-037	38x505
AH01-012	18x280	AH01-025*	25x400	AH01-038	38x600
AH01-013*	18x400	AH01-026	25x505		

FD-HEX-2 HAMMER DRILL BIT, L flute, 4 cutter



*:MOQ required. If special size required, please contact our business department.

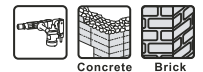

Part No.	Size(mm)	Part No.	Size(mm)	Part No.	Size(mm)
AH02-001	10x280	AH02-014	18x505	AH02-027	25x600
AH02-002*	10x400	AH02-015	18x600	AH02-028*	28x400
AH02-003	12x280	AH02-016	20x280	AH02-029	28x505
AH02-004*	12x400	AH02-017*	20x400	AH02-030	28x600
AH02-005	14x280	AH02-018	20x505	AH02-031	30x505
AH02-006*	14x400	AH02-019	20x600	AH02-032	30x600
AH02-007	14x505	AH02-020	22x280	AH02-033	32x505
AH02-008	16x280	AH02-021*	22x400	AH02-034	32x600
AH02-009*	16x400	AH02-022	22x505	AH02-035	35x505
AH02-010	16x505	AH02-023	22x600	AH02-036	35x600
AH02-011	16x600	AH02-024	25x280	AH02-037	38x505
AH02-012	18x280	AH02-025*	25x400	AH02-038	38x600
AH02-013*	18x400	AH02-026	25x505		

FD-CYL-1 MASONRY DRILL BIT, Round flute

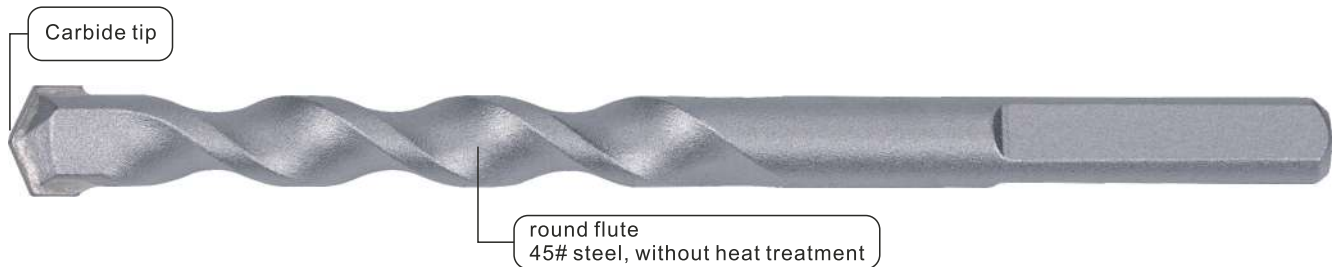

* :MOQ required.
If special size required, please contact our business department.

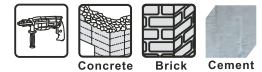

Part No.	Size(mm)	Part No.	Size(mm)	Part No.	Size(mm)
AC01-001	3x60	AC01-023	10x200	AC01-045*	15x150
AC01-002	4x70	AC01-024	10x300	AC01-046*	15x350
AC01-003	5x85	AC01-025*	10x400	AC01-047	16x150
AC01-004	6x100	AC01-026*	10x600	AC01-048	16x200
AC01-005	6x150	AC01-027*	11x150	AC01-049*	16x300
AC01-006	6x200	AC01-028*	11x200	AC01-050*	16x350
AC01-007	6x300	AC01-029*	11x300	AC01-051*	16x400
AC01-008*	6x400	AC01-030*	12x110	AC01-052*	16x600
AC01-009	7x100	AC01-031	12x120	AC01-053*	18x200
AC01-010	7x150	AC01-032	12x150	AC01-054*	18x300
AC01-011	8x110	AC01-033	12x200	AC01-055*	18x350
AC01-012	8x150	AC01-034*	12x300	AC01-056*	18x400
AC01-013	8x200	AC01-035*	12x350	AC01-057*	18x600
AC01-014	8x300	AC01-036*	12x400	AC01-058*	20x350
AC01-015*	8x400	AC01-037*	12x600	AC01-059*	20x400
AC01-016*	9x110	AC01-038*	13x150	AC01-060*	20x600
AC01-017	9x120	AC01-039	14x150	AC01-061*	22x350
AC01-018	9x150	AC01-040	14x200	AC01-062*	22x400
AC01-019	9x200	AC01-041*	14x300	AC01-063*	22x600
AC01-020	10x110	AC01-042*	14x350	AC01-064*	25x350
AC01-021	10x120	AC01-043*	14x400		
AC01-022	10x150	AC01-044*	14x600		

FD-HEX-3 1/4" HEXAGONAL SHANK MASONRY DRILL BIT



* :MOQ required.
If special size required, please contact our business department.



Part No.	Size(mm)	Part No.	Size(mm)	Part No.	Size(mm)
AH03-001	3x90	AH03-005	5x85	AH03-009	6x160
AH03-002	3.5x90	AH03-006	5x160	AH03-010*	6x200
AH03-003	4x70	AH03-007	5.5x100	AH03-011	6.5x100
AH03-004	4x160	AH03-008	6x100	AH03-012*	6.5x160

FD-CYL-2 HIGH QUALITY MASONRY DRILL BIT, Half round flute

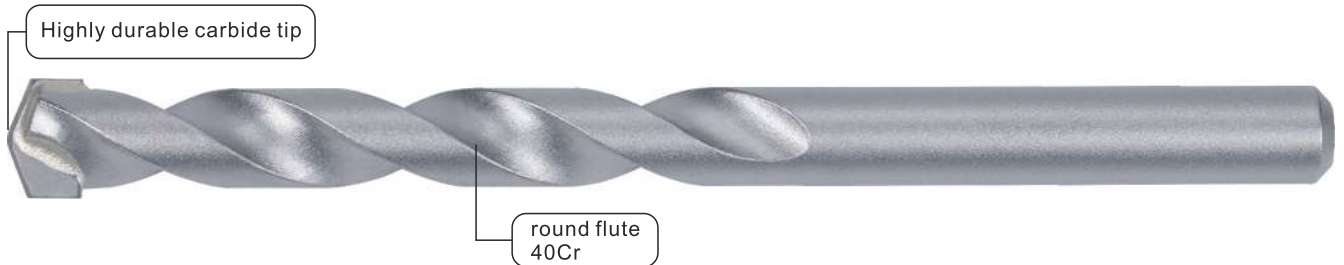

*:MOQ required.
If special size required, please contact our business department.

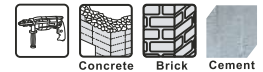

Part No.	Size(mm)	Part No.	Size(mm)	Part No.	Size(mm)
AC02-001	3x60	AC02-023	9x150	AC02-045	14x150
AC02-002*	3.5x60	AC02-024	9x200	AC02-046	14x200
AC02-003	4x70	AC02-025	9.5x150	AC02-047*	14x300
AC02-004	5x85	AC02-026*	9.5x300	AC02-048*	14x400
AC02-005	5x150	AC02-027	10x110	AC02-049*	14x600
AC02-006*	5.5x100	AC02-028	10x150	AC02-050	15x150
AC02-007	6x100	AC02-029	10x200	AC02-051*	15x300
AC02-008	6x150	AC02-030*	10x300	AC02-052	16x150
AC02-009	6x200	AC02-031*	10x400	AC02-053*	16x300
AC02-010*	6x300	AC02-032*	10x600	AC02-054*	16x400
AC02-011*	6x400	AC02-033	11x150	AC02-055*	16x600
AC02-012	6.5x100	AC02-034	11x200	AC02-056*	18x160
AC02-013	6.5x150	AC02-035*	11x300	AC02-057*	18x200
AC02-014*	6.5x300	AC02-036	12x120	AC02-058*	18x300
AC02-015	7x100	AC02-037	12x150	AC02-059*	18x400
AC02-016	7x150	AC02-038	12x200	AC02-060*	18x600
AC02-017	8x110	AC02-039*	12x300	AC02-061*	20x160
AC02-018	8x150	AC02-040*	12x400	AC02-062	20x300
AC02-019	8x200	AC02-041*	12x600	AC02-063*	20x400
AC02-020*	8x300	AC02-042	12.7x150	AC02-064*	20x600
AC02-021*	8x400	AC02-043*	12.7x300	AC02-065*	22x300
AC02-022	9x110	AC02-044	13x150	AC02-066*	22x400

FD-HEX-4 1/4" HEXAGONAL SHANK MASONRY DRILL BIT



*:MOQ required.
If special size required, please contact our business department.



Part No.	Size(mm)	Part No.	Size(mm)	Part No.	Size(mm)
AH04-001	3x90	AH04-005	5x85	AH04-009*	6x160
AH04-002*	3.5x90	AH04-006*	5x160	AH04-010*	6x200
AH04-003	4x70	AH04-007*	5.5x100	AH04-011	6.5x100
AH04-004*	4x160	AH04-008	6x100	AH04-012*	6.5x160

CARBIDE TIPPED MASONRY DRILL BITS



FD-CYL-3 MULTI-PURPOSE DRILL BIT, Round flute



MOQ required.
If special size required, please contact our business department.



Part No.	Size(mm)	Part No.	Size(mm)	Part No.	Size(mm)
AC03-001	3x70	AC03-011	6.5x150	AC03-021	12x200
AC03-002	4x75	AC03-012	7x100	AC03-022	12x400
AC03-003	5x85	AC03-013	7x150	AC03-023	14x150
AC03-004	5x150	AC03-014	8x120	AC03-024	14x300
AC03-005	5.5x85	AC03-015	8x150	AC03-025	14x400
AC03-006	5.5x150	AC03-016	8x200	AC03-026	16x160
AC03-007	6x100	AC03-017	10x120	AC03-027	16x400
AC03-008	6x150	AC03-018	10x150	AC03-028	20x400
AC03-009	6x200	AC03-019	10x200		
AC03-010	6.5x100	AC03-020	12x150		

FD-CYL-4 MASONRY DRILL BIT, U flute, PGM



MOQ required.
If special size required, please contact our business department.



Part No.	Size(mm)	Part No.	Size(mm)	Part No.	Size(mm)
AC04-001	4x75	AC04-014	10x120	AC04-027	14x150
AC04-002	5x85	AC04-015	10x150	AC04-028	14x300
AC04-003	5x150	AC04-016	10x200	AC04-029	14x400
AC04-004	6x100	AC04-017	10x300	AC04-030	15x160
AC04-005	6x150	AC04-018	10x400	AC04-031	16x160
AC04-006	6x200	AC04-019	11x150	AC04-032	16x400
AC04-007	6x400	AC04-020	12x120	AC04-033	18x160
AC04-008	7x100	AC04-021	12x150	AC04-034	18x400
AC04-009	7x150	AC04-022	12x200	AC04-035	20x160
AC04-010	8x120	AC04-023	12x300	AC04-036	20x400
AC04-011	8x150	AC04-024	12x400	AC04-037	22x160
AC04-012	8x200	AC04-025	13x150	AC04-038	22x400
AC04-013	8x400	AC04-026	13x300	AC04-039	25x160

MULTI-PURPOSE DRILL BIT, U flute

- Triangle Shank FD-CYL-5
- Straight Shank FD-CYL-6
- 1/4" Hex Shank FD-CYL-7

MOQ required.
 If special size required, please contact our business department.



Size(mm)	● Part No.	● Part No.	● Part No.
3x70		AC06-001	
3x90			AC07-001
4x75		AC06-002	
4x90			AC07-002
4x150		AC06-003	AC07-003
5x85		AC06-004	AC07-004
5x100		AC06-005	AC07-005
5x150		AC06-006	AC07-006
5.5x100		AC06-007	AC07-007
5.5x150		AC06-008	AC07-008
6x100	AC05-001	AC06-009	AC07-009
6x150	AC05-002	AC06-010	AC07-010
6.5x100	AC05-003	AC06-011	AC07-011
6.5x150	AC05-004	AC06-012	AC07-012
7x100	AC05-005	AC06-013	AC07-013
7x150	AC05-006	AC06-014	AC07-014
8x120	AC05-007	AC06-015	AC07-015
8x150	AC05-008	AC06-016	AC07-016
8x200	AC05-009	AC06-017	AC07-017
8x260	AC05-010	AC06-018	AC07-018
9x120	AC05-011	AC06-019	
10x120	AC05-012	AC06-020	AC07-019
10x150	AC05-013	AC06-021	AC07-020
10x200	AC05-014	AC06-022	AC07-021
10x260	AC05-015	AC06-023	AC07-022
11x150	AC05-016	AC06-024	AC07-023
12x150	AC05-017	AC06-025	AC07-024
12x200	AC05-018	AC06-026	AC07-025
12x260	AC05-019	AC06-027	AC07-026
13x150	AC05-020	AC06-028	AC07-027
13x200	AC05-021	AC06-029	AC07-028
14x150	AC05-022	AC06-030	
14x200	AC05-023	AC06-031	
14x260	AC05-024	AC06-032	

CARBIDE TIPPED MASONRY DRILL BITS



FD-CYL-8 Glass & Tile Drill Bits

Sandblast or Black oxide



MOQ required.
If special size required, please contact our business department.

Part No.	Size(mm)
AC08-001	3x75
AC08-002	4x75
AC08-003	5x75
AC08-004	6x75
AC08-005	6x100
AC08-006	6.5x75
AC08-007	6.5x100
AC08-008	8x120
AC08-009	10x120
AC08-010	12x120

FD-CYL-9 Glass & Tile Drill Bits, 4 cutter

Sandblast or Black oxide

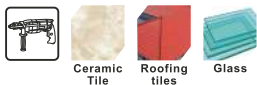

MOQ required.
If special size required, please contact our business department.

Part No.	Size(mm)
AC09-001	4x75
AC09-002	5x75
AC09-003	6x75
AC09-004	6x100
AC09-005	6.5x75
AC09-006	6.5x100
AC09-007	8x120
AC09-008	10x120
AC09-009	12x120

FD-HEX-5 1/4" Hex Shank Glass & Tile Drill Bits

Sandblast or Black oxide



MOQ required.
If special size required, please contact our business department.

Part No.	Size(mm)
AH05-001	3x76
AH05-002	4x76
AH05-003	5x76
AH05-004	6x76
AH05-005	6.5x76
AH05-006	8x76
AH05-007	10x80
AH05-008	10x120
AH05-009	12x80
AH05-010	12x120

FD-HEX-6 1/4" Hex Shank Glass & Tile Drill Bits, 4 cutter

Sandblast or Black oxide

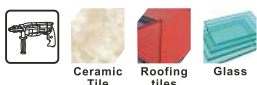

MOQ required.
If special size required, please contact our business department.

Part No.	Size(mm)
AH05-001	4x76
AH05-002	5x76
AH05-003	6x76
AH05-004	6.5x76
AH05-005	8x76
AH05-006	10x80
AH05-007	10x120
AH05-008	12x80
AH05-009	12x120



CARBIDE TIPPED MASONRY DRILL BIT SETS

Employing high quality alloy steel for drilling body and YG carbide alloy for drilling tip, and in combination with various types of electric hammer. The drill is one of the most efficient tools suitably and widely used for hole drilling in hard materials like concrete/brick in construction & installation industries.

FANGDAWANG HOLDING

CARBIDE TIPPED MASONRY DRILL BIT SETS



3PCS DRILL BIT SET



FD-SET03A



FD-SET03B



FD-SET03C

FD-SET03A: 5x110mm 6x160mm 8x160mm

FD-SET03B: 5x110mm 6x110mm 8x160mm

FD-SET03C: 6x160mm 8x160mm 10x160mm

4PCS DRILL BIT SET



FD-SET04A



FD-SET04B



FD-SET04C

FD-SET04A: 5x110mm 6x110mm 8x110mm 10x110mm

FD-SET04B: 5x160mm 6x160mm 8x160mm 10x160mm

FD-SET04C: 5x110mm 6x110mm 8x160mm 10x160mm

5PCS DRILL BIT SET



FD-SET05A



FD-SET05B

FD-SET05A: 5x110mm 6x160mm 8x160mm 10x160mm 12x160mm

FD-SET05B: 5x110mm 6x110mm 6x160mm 8x160mm 10x160mm

5PCS DRILL BIT SET



FD-SET05D



FD-SET05E

FD-SET05D: 5x160mm 6x160mm 8x160mm 10x160mm 12x160mm

FD-SET05E: 5x110mm 6x110mm 8x110mm 8x160mm 10x160mm

5PCS DRILL BIT SET



FD-SET05C

FD-SET05C: 4x70mm 5x85mm 6x100mm 8x110mm 10x110mm

6PCS DRILL BIT SET



FD-SET06A

FD-SET06A: 6x110mm 8x110mm 10x110mm 6x160mm
8x160mm 10x160mm

CARBIDE TIPPED MASONRY DRILL BIT SETS

方大王®

10PCS DRILL BIT SET



FD-SET10A

FD-SET17A: 6x110mm 8x160mm 10x210mm 12x210mm
10x460mm 12X460mm 16x460mm 20x460mm
POINT CHISEL 250mm
FLAT CHISEL 20x250mm

13PCS DRILL BIT SET



FD-SET13A

FD-SET13A: 5x110mm 6x110mm 7x110mm 8x110mm
6x160mm 7x160mm 8x160mm 10X160mm
12x160mm 14x160mm 16x160mm
POINT CHISEL 250mm
FLAT CHISEL 20x250mm

17PCS DRILL BIT SET



FD-SET17C

FD-SET17C: 5x110mm 6x110mm 8x110mm 10x110mm
6x160mm 8X160mm 10x160mm 12x160mm
8x210mm 10x210mm 12x260mm 14x260mm
POINT CHISEL 250mm 140mm
FLAT CHISEL 20x250mm 20x140mm 40x250mm



CHISELS

The chisel can be used with electric hammer and it is widely applicable and high efficient chiselling hole, cutting, chiselling groove tool for concrete and brick wall. Our products include bull point、small flat chisel、big flat chisel、gouge and groove chisel. The chisel length can be made according to customers' requirements. The shank type can be selected according to below list of shank structure.



Point chisel

General chiselling work in concrete and brickwork.

Flat chisel

General chiselling work in concrete and brickwork. Targeted chiselling action.

Spade chisel

Broad area material removal. Universal use.

Gouging chisel

Cutting narrow channels in concrete and brickwork.

Tile chisel

Easy, fast tile removal.

FD-B01



FD-B07



FD-B16



FD-B02



FD-B08

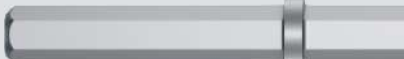

FD-B17



FD-B03



FD-B10



FD-B18



FD-B04



FD-B13



FD-B19



FD-B05



FD-B14



FD-B20



FD-B06



FD-B15



FD-B0101



SIZE:14x250mm 17x250mm

FD-B0102



SIZE:14x250x20mm 17x250x22mm

FD-B0103



SIZE:14x250x40mm 14x250x70mm

FD-B0104



SIZE:14x250x22mm

FD-B0105



SIZE:14x250x40mm 10°

FD-B0201



SIZE:18x300mm 18x400mm 18x600mm

FD-B0202



SIZE:18x300x25mm 18x400x25mm 18x600x25mm

FD-B0203

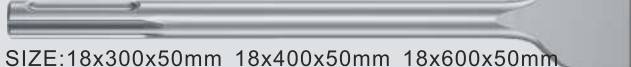

SIZE:18x300x50mm 18x400x50mm 18x600x50mm
18x300x75mm 18x400x75mm 18x600x75mm

FD-B0204



SIZE:18x300x26mm 18x400x26mm 18x600x26mm

FD-B0205



SIZE:18x300x50mm 10° 18x400x50mm 10° 18x600x50mm 10°

FD-B0301



SIZE:17x280mm 17x450mm 21x320mm 21x450mm

FD-B0302

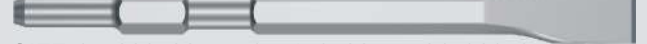

SIZE:17x280x22mm 17x450x22mm 21x320x25mm
21x450x25mm

FD-B0303

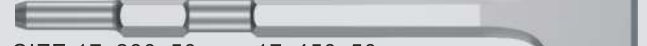

SIZE:17x280x50mm 17x450x50mm
21x320x50mm 21x450x50mm 17x280x75mm

FD-B0401



SIZE:17x280mm 21x320mm

FD-B0402



SIZE:17x280x22mm 21x320x22mm

FD-B0501



SIZE:19x300mm 19x400mm 19x600mm

FD-B0502

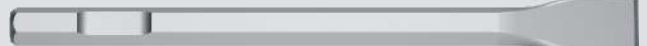

SIZE:19x300x25mm 19x400x25mm 19x600x25mm

FD-B0601

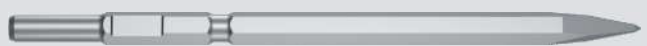

SIZE:21x300mm 21x450mm 21x600mm

FD-B0602



SIZE:21x320x25mm 21x450x25mm 21x600x25mm

FD-B0701

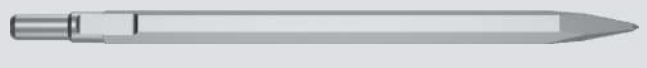

SIZE:19x400mm

FD-B0702



SIZE:19x400x25mm

FD-B0801



SIZE:19x330mm 22x450mm 25x500mm
28x520mm 32x550mm 28x410mm

CHISELS

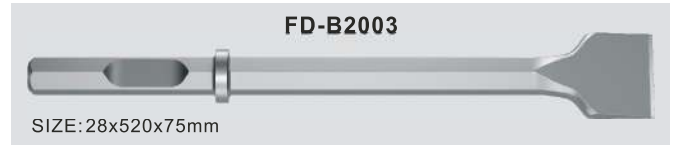
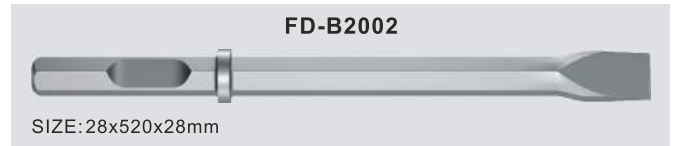
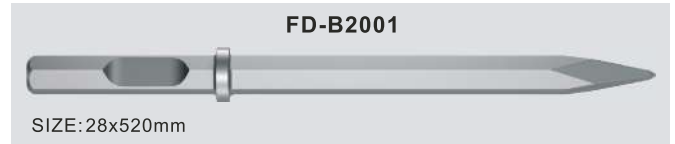
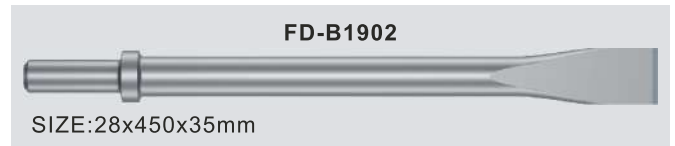
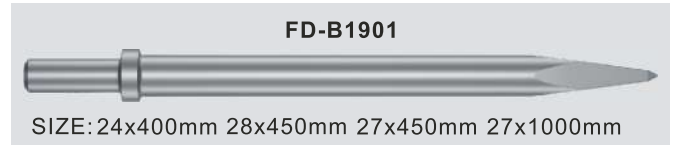
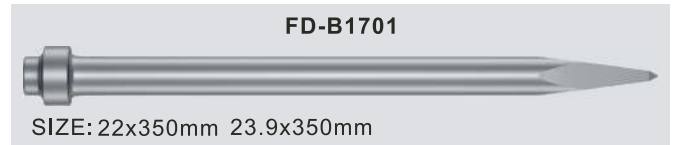
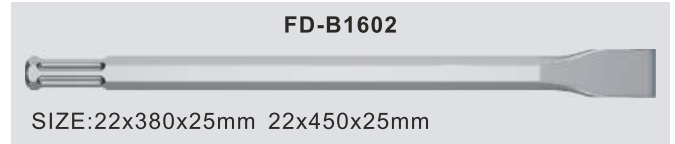
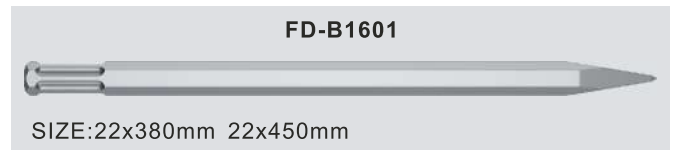
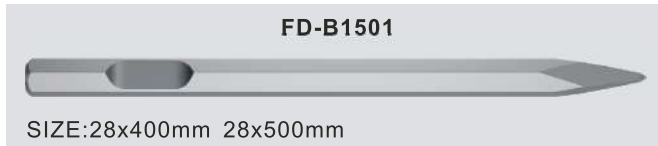
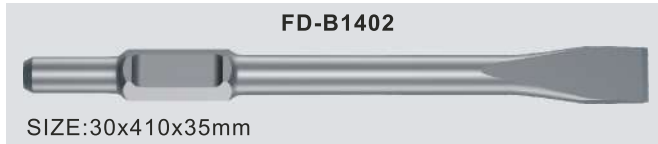
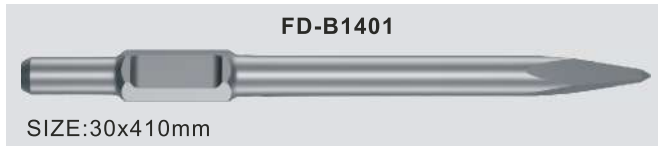
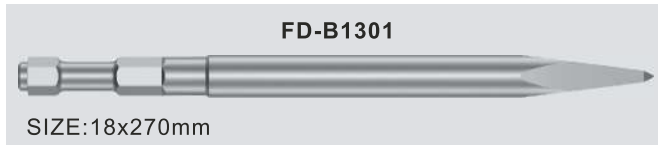
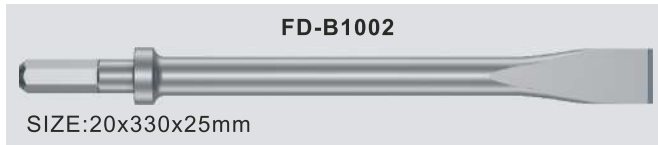
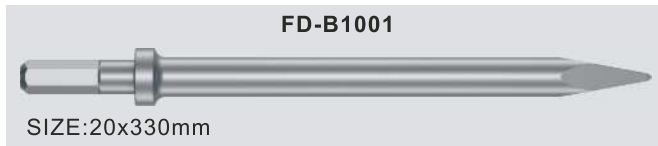
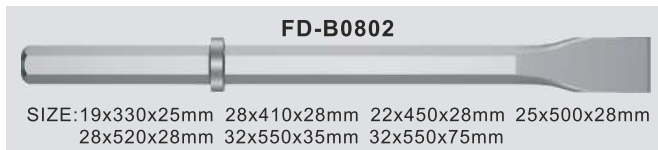

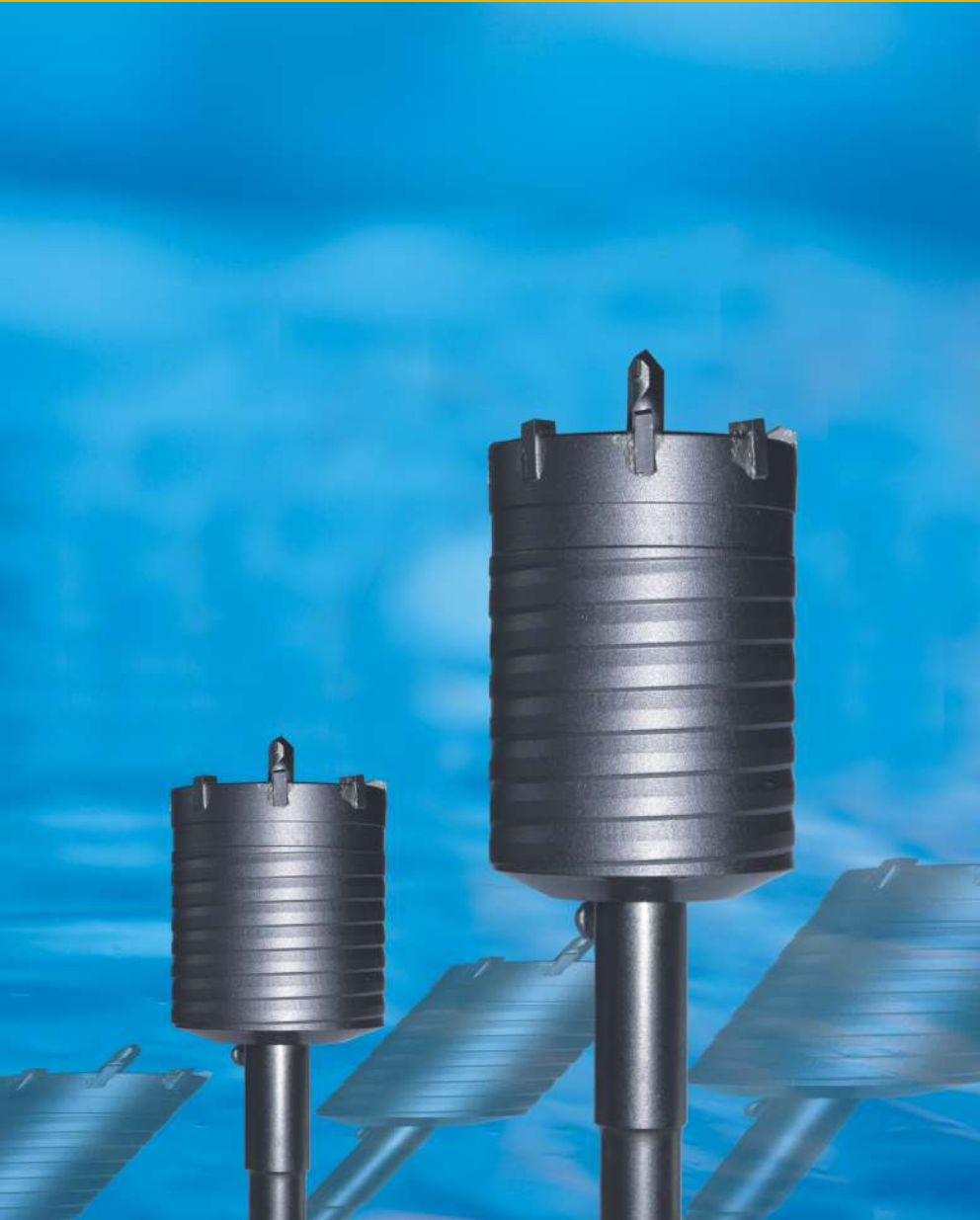

HOLE SAWS

FANGDAWANG HOLDING

HOLE SAWS

FD-C01 HOLLOW ELECTRIC HAMMER DRILL



空心电锤钻是由导向钻，加上专用连接杆配套，在各种结构的电锤机上加工打孔的工具，是安装，装璜行业的新型工具。空心电锤钻的连接杆，按前页柄部结构选用。

Hollow Electric Hammer Drill is composed of a guided drill and connecting rod. It can be fitted to various electric hammers as a boring tool for processing large holes. It is a novel tool for installation and decoration trades. The connecting rod of Hollow Electric Hammer Drill can be selected according to the front page shank structure.



O.D.d	35	40	50	55	60
	65	68	70	75	80
	85	90	100	120	150

FD-D02



1-PLY CUTTER <35mm
3-PLY CUTTERS ≥35mm
Diameter: 14~200mm
Depth up to 25mm



FD-D03

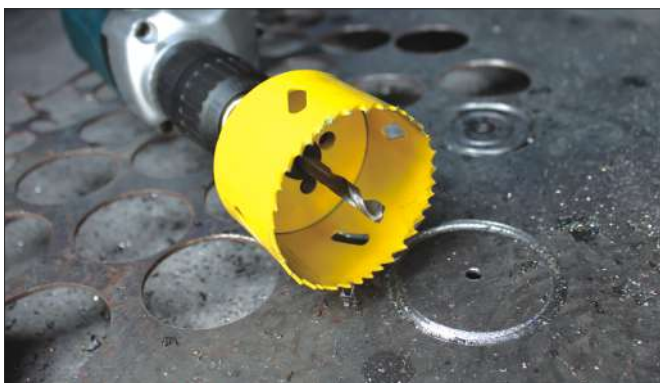

FD-D04



FD-D05



FD-PLUS ADAPTOR



FD-ADA1



FD-ADA2



**HSS STRAIGHT SHANK
TWIST DRILL**

FANGDA HOLLOW DRILLING

FD-H01 TWIST DRILLS (FULLY GROUND)



Part No.	Diameter	Part No.	Diameter
FD-H0101	1.0	FD-H0117	6.0
FD-H0102	1.5	FD-H0118	5.2
FD-H0103	2.0	FD-H0119	6.5
FD-H0104	2.5	FD-H0120	6.5
FD-H0105	2.8	FD-H0121	7.0
FD-H0106	3.0	FD-H0122	7.2
FD-H0107	3.2	FD-H0123	7.5
FD-H0108	3.5	FD-H0124	8.0
FD-H0109	3.8	FD-H0125	8.5
FD-H0110	4.0	FD-H0126	9.0
FD-H0111	4.2	FD-H0127	10.0
FD-H0112	4.8	FD-H0128	11.0
FD-H0113	5.0	FD-H0129	12.0
FD-H0114	5.2	FD-H0130	13.0
FD-H0115	5.5	FD-H0131	14.0
FD-H0116	5.8		

FD-H03 TWIST DRILLS



Part No.	Diameter	Part No.	Diameter
FD-H0301	1.0	FD-H0317	6.0
FD-H0302	1.5	FD-H0318	5.2
FD-H0303	2.0	FD-H0319	6.5
FD-H0304	2.5	FD-H0320	6.5
FD-H0305	2.8	FD-H0321	7.0
FD-H0306	3.0	FD-H0322	7.2
FD-H0307	3.2	FD-H0323	7.5
FD-H0308	3.5	FD-H0324	8.0
FD-H0309	3.8	FD-H0325	8.5
FD-H0310	4.0	FD-H0326	9.0
FD-H0311	4.2	FD-H0327	10.0
FD-H0312	4.8	FD-H0328	11.0
FD-H0313	5.0	FD-H0329	12.0
FD-H0314	5.2	FD-H0330	13.0
FD-H0315	5.5	FD-H0331	14.0
FD-H0316	5.8		

HSS STRAIGHT SHANK TWIST DRILL

FD-HSS013A



DIAMETER SET	PER UNIT	FINISHING CODE
1.5-6.5×0.5mm +3,2+4.8mm	13	*

FD-HSS019A



DIAMETER SET	PER UNIT	FINISHING CODE
1-10×0.5mm	19	*

FD-HSS025A



DIAMETER SET	PER UNIT	FINISHING CODE
1-13×0.5mm	25	*



ROUTER BIT SETS

FANGDA router bit sets possess high quality, fine outer packing and various types. They apply the metric system and British system. Except standard sets in the catalogue, we can manufacture according to demands of a certain order.

FANGDA HOLDING

ROUTER BIT SETS



FD-N003E

3件套榫合刀 3PCS RAIL & STILE BITS SET



NAME OF COMMODITY	SIZE
卢西榫合刀 ROMAN OGEE RAIL & STILE BIT	1/2" X1-5/8" I
卢西榫合刀 ROMAN OGEE RAIL & STILE BIT	1/2" X1-5/8" II
卢西门板刀 RAISED PANEL BIT WITH BACK CUTTERS	1/2"X3-1/8"

FD-N003H

3件套榫合刀 3PCS RAIL & STILE BITS SET



NAME OF COMMODITY	SIZE
门斗榫合刀 ROMAN CLASSICAL RAIL & STILE BIT	1/2" X1-5/8" I
门斗榫合刀 ROMAN CLASSICAL RAIL & STILE BIT	1/2" X1-5/8" II
侧R门板线刀 TRADITIONAL BIT	1/2" X3-1/8"

FD-N006A

6件套榫合刀 6PCS RAIL & STILE BITS SET



NAME OF COMMODITY	SIZE
圆角榫合刀 COVE RAIL & STILE BIT	1/2" X1-5/8" I
圆角榫合刀 COVE RAIL & STILE BIT	1/2" X1-5/8" II
斜边榫合刀 BEVELED RAIL & STILE BIT	1/2" X2-5/8"
榫合刀 REVERSIBLE GLUE BIT	1/2" X1-3/4"
屈锁刀 DRAW LOCK BIT	1/2" X2"
圆角门板刀 COVE RAISED PANEL BIT	1/2" X1-5/8"

FD-006A

6支装木工铣刀 6PCS/SET ROUTER BIT



NAME OF COMMODITY	SIZE
倒角刀 COVE BIT	R6.3mm
直刀 STRAIGHT BIT	6mm
圆角刀 ROUND BEADING OVER BIT	R6.3mm
修边刀 BEARING FLUSH TRIM BIT	12.7mm
直刀 STRAIGHT BIT	12mm
子口荀刀 DOVETAIL BIT	12.7mm

FD-008A

8支装木工铣刀 8PCS/SET ROUTER BIT



NAME OF COMMODITY	SIZE
直刀 STRAIGHT BIT	1/4 "
直刀 STRAIGHT BIT	1/2 "
修边刀 FLUSH TRIM BIT	1/2 "
子口荀刀 DOVETAIL BIT	1/2 "
槽口刀 SLOT CUTTER BIT	3/8 "
45° 斜角刀 45° CHAMFER BIT	1/2 "
圆角刀 ROUND BEADING OVER BIT	R3/8 "
开榫刀 MORTSNG BIT	1/2 "
匙孔刀 KEYHOLE BIT	3/8 "

FD-012A

12支装木工铣刀 12PCS/SET ROUTER BIT



NAME OF COMMODITY	SIZE
清底刀 CLEANING BOTTOM BIT	8mm
清底刀 CLEANING BOTTOM BIT	16mm
圆底刀 CORE BOX BIT	R6mm
60° "V"型刀 60° "V" GROOVING BIT	15mm
子口荀刀 DOVERAIL BIT	16mm
修边刀 BEARING FLUSH TRIM BIT	19mm
45° 斜角刀 45° CHAMFER BIT	10mm
圆角刀 ROUND BEADING OVER BIT	R10mm
圆角刀 ROUND BEADING OVER BIT	R6.3mm
倒角刀 ROUNDING COVE BIT	R10mm
倒角刀 ROUNDING COVE BIT	R6mm
卢西线刀 ROMAN OGEE BIT	R6.3mm

ROUTER BIT SETS



FD-012B

12支装木工铣刀 12PCS/SET ROUTER BIT



NAME OF COMMODITY	SIZE
直刀 STRAIGHT BIT	6mm
直刀 STRAIGHT BIT	12mm
直刀 STRAIGHT BIT	16mm
90° "V"型刀 90° "V"GROOVING BIT	12.7mm
子口荀刀 DOVERAIL BIT	12.7mm
45° 斜角刀 45° CHAMFER BIT	32 mm
修边刀 BEARING FLUSH TRIM BIT	12.7mm
圆角刀 ROUND BEADING OVER BIT	R6.3mm
圆角刀 ROUND BEADING OVER BIT	R9.5mm
圆底刀 CORE BOX BIT	R6.3mm
倒角刀 ROUNDING COVE BIT	R6.3mm
卢西线刀 ROMAN OGEE BIT	R4mm



FD-012T

12支装木工铣刀 12PCS/SET ROUTER BIT



NAME OF COMMODITY	SIZE
直刀 STRAIGHT BIT	4mm
直刀 STRAIGHT BIT	14mm
直刀 STRAIGHT BIT	16mm
修边刀 BEARING FLUSH TRIM BIT	12.7mm
90°"V"型刀 90°"V" GROOVING BIT	12.7mm
子口荀刀 DOVETAIL BIT	16mm
圆角刀 ROUND BEADING OVER BIT	R4.8mm
圆角刀 ROUND BEADING OVER BIT	R9.5mm
卢西线刀 ROMAN OGEE BIT	R4mm
卢西线刀 ROMAN OGEE BIT	R6.35mm
倒角刀 ROUNDING COVE BIT	R12.7mm
跳桌刀 CLASSICAL BIT	R4.8mmXR6.35mm

FD-015A

15支装木工铣刀 15PCS/SET ROUTER BIT



NAME OF COMMODITY	SIZE
单节刀 PANEL PILOT BIT	1/4"
90° "V"型刀 90° "V"GROOVING BIT	3/8"
直刀 STRAIGHT BIT	1/4"
开榫刀 MORTISING BIT	1/2"
直刀 STRAIGHT BIT	1/2"
直刀 STRAIGHT BIT	3/4"
修边刀 BEARING FLUSH TRIM BIT	1/2" × 1/2"
子口荀刀 DOVETAIL BIT	1/2"
槽口刀 SLOT CUTTER BIT	3/8"
45° 斜角刀 45° CHAMFER BIT	1/2"
圆角刀 ROUND BEADING OVER BIT	R3/8"
倒角刀 ROUNDING COVE BIT	R1/2"
卢西线刀 ROMAN OGEE BIT	R5/32"
7° 整体斜角刀 7° BEVEL TRIM BIT	1/4"
整体修边刀 FLUSH TRIM BIT	3/8"

FD-015B

15支装木工铣刀 15PCS/SET ROUTER BIT



NAME OF COMMODITY	SIZE
直刀 STRAIGHT BIT	5mm
直刀 STRAIGHT BIT	6mm
直刀 STRAIGHT BIT	10mm
直刀 STRAIGHT BIT	12.7mm
直刀 STRAIGHT BIT	19mm
修边刀 BEARING FLUSH TRIM BIT	9.5mm × 25mm
圆底刀 COVE BOX BIT	R3mm
子口荀刀 DOVETAIL BIT	12.7mm
"V"型刀 "V"GROOVING BIT	12.7mm
"V"型刀 "V"GROOVING BIT	25.4mm
圆角刀 ROUND BEADING OVER BIT	R9.5mm
倒角刀 ROUNDING COVE BIT	R9.5mm
卢西线刀 ROMAN OGEE BIT	R4mm
45° 斜角刀 45° CHAMFER BIT	12.7mm
槽口刀 SLOT CUTTER BIT	6.35mm

ROUTER BIT SETS



FD-015D

15支装木工铣刀 15PCS/SET ROUTER BIT



NAME OF COMMODITY	SIZE
单节刀 PANEL PILOT BIT	1/4"
90° "V"型刀 90° "V"GROOVING BIT	3/8"
直刀 STRAIGHT BIT	1/4"
开榫刀 MORTISING BIT	1/2"
直刀 STRAIGHT BIT	1/2"
直刀 STRAIGHT BIT	3/4"
修边刀 BEARING FLUSH TRIM BIT	1/2" × 1/2"
子口荀刀 DOVETAIL BIT	1/2"
槽口刀 SLOT CUTTER BIT	3/8"
45° 斜角刀 45° CHAMFER BIT	1/2"
圆角刀 ROUND BEADING OVER BIT	R3/8"
倒角刀 ROUNDING COVE BIT	R1/2"
户西线刀 ROMAN OGEE BIT	R5/32"
单刃直刀 STRAIGHT BIT	3/16"
圆底刀 CORE BOX BIT	R1/8"

FD-015X

15支装木工铣刀 15PCS/SET ROUTER BIT



NAME OF COMMODITY	SIZE
直刀 STRAIGHT BIT	3mm
直刀 STRAIGHT BIT	6mm
直刀 STRAIGHT BIT	12mm
直刀 STRAIGHT BIT	16mm
修边刀 BEARING FLUSH TRIM BIT	12.7mm
90°"V"型刀 90°"V" GROOVING BIT	12.7mm
子口荀刀 DOVETAIL BIT	12.7mm
圆角刀 ROUND BEADING OVER BIT	R9.5mm
户西线刀 ROMAN OGEE BIT	R4mm
倒角刀 ROUNDING COVE BIT	R6.35mm
圆底刀 CORE BOX BIT	R3.2mm
圆底刀 CORE BOX BIT	R6.35mm
45° 斜角刀 45° CHAMFER BIT	32mm
单节刀 PANEL PILOT BIT	6.35mm
开榫刀 MORTISING BIT	12.7mm

FD-024A

24支装木工铣刀 24PCS/SET ROUTER BIT



NAME OF COMMODITY	SIZE
开榫刀 MORTISING BIT	1/2"
齐头刀 COMBINATION BEVEL BIT	1/2"
子口荀刀 DOVETAIL BIT	3/8"
子口荀刀 DOVETAIL BIT	1/2"
90° "V"型刀 90° "V"GROOVING BIT	1/2"
深圆底刀 ROUND NOSE BIT	R1/8"
深圆底刀 ROUND NOSE BIT	R1/4"
斜角修边刀 BEARING FLUSH TRIM BIT	3/8"
单节刀 PANEL PILOT BIT	1/4"
直刀 STRAIGHT BIT	1/4"
直刀 STRAIGHT BIT	3/8"
直刀 STRAIGHT BIT	1/2"
直刀 STRAIGHT BIT	3/4"
修边刀 BEARING FLUSH TRIM BIT	1/2"
圆角刀 ROUNDING BEADING OVER BIT	R1/8"
圆角刀 ROUNDING BEADING OVER BIT	R3/16"
圆角刀 ROUNDING BEADING OVER BIT	R1/4"
圆角刀 ROUNDING OVER BIT	R3/8"
倒角刀 ROUNDING COVE BIT	R1/4"
倒角刀 ROUNDING COVE BIT	R3/8"
斜角刀 CHAMFER BIT	1/2"
户西线刀 ROMAN OGEE BIT	R5/32"
槽口刀 SLOT CUTTER BIT	1/4"
槽口刀 RABBETING BIT	1/2"

ROUTER BIT SETS



FD-035A

35支装木工铣刀 35PCS/SET ROUTER BIT



NAME OF COMMODITY	SIZE
修边刀 BEARING FLUSH TRIM BIT	3/8" × 1/2"
修边刀 BEARING FLUSH TRIM BIT	3/8" × 1"
修边刀 BEARING FLUSH TRIM BIT	1/2" × 1/2"
修边刀 BEARING FLUSH TRIM BIT	1/2" × 1"
修边刀 BEARING FLUSH TRIM BIT	3/4" × 3/4"
槽口刀 SLOT CUTTER BIT	1/4"
槽口刀 SLOT CUTTER BIT	5/16"
槽口刀 SLOT CUTTER BIT	3/8"
槽口刀 SLOT CUTTER BIT	1/2"
45° 斜角刀 45° CHAMFER BIT	3/8"
45° 斜角刀 45° CHAMFER BIT	1/2"
45° 斜角刀 45° CHAMFER BIT	5/8"
45° 斜角刀 45° CHAMFER BIT	3/4"
圆角刀 ROUNDING BEADING OVER BIT	R1/4"
圆角刀 ROUNDING BEADING OVER BIT	R3/8"
圆角刀 ROUNDING BEADING OVER BIT	R1/2"
敏仔刀 ROUNDING OVER BIT	R1/4"
敏仔刀 ROUNDING OVER BIT	R3/8"
敏仔刀 ROUNDING OVER BIT	R1/2"
倒角刀 ROUNDING COVE BIT	R1/4"
倒角刀 ROUNDING COVE BIT	R3/8"
倒角刀 ROUNDING COVE BIT	R1/2"
户西线刀 ROMAN OGEE BIT	R5/32"
户西线刀 ROMAN OGEE BIT	R7/32"
户西线刀 ROMAN OGEE BIT	R9/32"
跳桌角线刀 OGEE PANEL BIT	R1/4"
跳桌角线刀 OGEE PANEL BIT	R3/8"
平角弧线刀 OGEE FLUTE BIT	R3/16"
凸敏仔线刀 CLASSIC COVE BIT	R5/16"
三弧桌刀 WAVY EDGE BIT	R3/16"
跳桌刀 CLASSICAL BIT	R3/16"
跳桌刀 CLASSICAL BIT	R1/4"
门斗条线刀 DOUBLE OGEE PANEL BIT	R1/8"
门斗条线刀 DOUBLE OGEE PANEL BIT	R3/16"
门斗条线刀 DOUBLE OGEE PANEL BIT	R1/4"

FD-035B

35支装木工铣刀 35PCS/SET ROUTER BIT



NAME OF COMMODITY	SIZE
直刀 STRAIGHT BIT	3/16"
直刀 STRAIGHT BIT	1/4"
直刀 STRAIGHT BIT	15/32"
直刀 STRAIGHT BIT	1/2"
直刀 STRAIGHT BIT	5/8"
单节刀 PANEL PILOT BIT	1/4"
圆底刀 CORE BOX BIT	R1/8"
90° "V"型刀 90° "V"GROOVING BIT	3/8"
开榫刀 MORTISING BIT	1/2"
子口荀刀 DOVETAIL BIT	1/2"
修边刀 BEARING FLUSH TRIM BIT	3/8×1/2"
修边刀 BEARING FLUSH TRIM BIT	3/8×1"
修边刀 BEARING FLUSH TRIM BIT	1/2×1/2"
槽口刀 SLOT CUTTER BIT	1/4"
槽口刀 SLOT CUTTER BIT	5/16"
槽口刀 SLOT CUTTER BIT	3/8"
槽口刀 SLOT CUTTER BIT	1/2"
45° 斜角刀 45° CHAMFER BIT	3/8"
45° 斜角刀 45° CHAMFER BIT	1/2"
45° 斜角刀 45° CHAMFER BIT	5/8"
45° 斜角刀 45° CHAMFER BIT	3/4"
圆角刀 ROUNDING BEADING OVER BIT	R1/4"
圆角刀 ROUNDING BEADING OVER BIT	R3/8"
圆角刀 ROUNDING BEADING OVER BIT	R1/2"
敏仔刀 ROUNDING OVER BIT	R1/4"
敏仔刀 ROUNDING OVER BIT	R3/8"
敏仔刀 ROUNDING OVER BIT	R1/2"
倒角刀 ROUNDING COVE BIT	R1/4"
倒角刀 ROUNDING COVE BIT	R3/8"
倒角刀 ROUNDING COVE BIT	R1/2"
户西线刀 ROMAN OGEE BIT	R5/32"
户西线刀 ROMAN OGEE BIT	R7/32"
户西线刀 ROMAN OGEE BIT	R9/32"
跳桌线刀 OGEE PANEL BIT	R1/4"
跳桌线刀 OGEE PANEL BIT	R3/16"



NAME OF COMMODITY	SIZE
直刀STRAIGHT BIT	1/8"
直刀STRAIGHT BIT	1/4"
直刀STRAIGHT BIT	15/32"
直刀STRAIGHT BIT	1/2"
直刀STRAIGHT BIT	3/8"
直刀STRAIGHT BIT	3/4"
圆底刀CORE BOX BIT	R1/8"
圆底刀CORE BOX BIT	R1/4"
修边刀BEARING FLUSH TRIM BIT	3/8" × 1/2"
修边刀BEARING FLUSH TRIM BIT	3/8" × 1"
修边刀BEARING FLUSH TRIM BIT	1/2" × 1/2"
修边刀BEARING FLUSH TRIM BIT	1/2" × 1"
修边刀BEARING FLUSH TRIM BIT	3/4" × 3/4"
45° 斜角刀45° CHAMFER BIT	1/2"
户西线刀ROMAN OGEE BIT	R5/32"
户西线刀ROMAN OGEE BIT	R1/4"
倒角刀ROUNDING COVE BIT	R1/4"
倒角刀ROUNDING COVE BIT	R3/8"
三弧线刀WAVE EDGE BIT	R3/16"
子口荀刀DOVETAIL BIT	1/2"
子口荀刀DOVETAIL BIT	9/16"
开榫刀MORTISING BIT	1/2"
深圆底刀ROUNDING NOSE BIT	1/2"
90° "V" 型刀90° "V" GROOVING BIT	1/2"
单节刀PANEL PILOT BIT	1/4"
圆角刀ROUNDING BEADING OVER BIT	R1/4"
圆角刀ROUNDING BEADING OVER BIT	R3/8"
圆角刀ROUNDING BEADING OVER BIT	R1/2"
槽口刀SLOT CUTTER BIT	1/4"
槽口刀SLOT CUTTER BIT	5/16"
槽口刀SLOT CUTTER BIT	3/8"
敏仔刀ROUNDING BEADING BIT	R1/2"
凸敏仔刀CLASSICAL COVE BIT	R5/16"
门斗条线刀ROMAN CLASSICAL BIT	R3/16"
门斗条线刀ROMAN CLASSICAL BIT	R1/4"

FD-050A

50支装木工铣刀 50PCS/SET ROUTER BIT



NAME OF COMMODITY	SIZE
直刀 STRAIGHT BIT	3/16"
直刀 STRAIGHT BIT	1/4"
直刀 STRAIGHT BIT	5/16"
直刀 STRAIGHT BIT	3/8"
直刀 STRAIGHT BIT	1/2"
直刀 STRAIGHT BIT	5/8"
直刀 STRAIGHT BIT	3/4"
90° "V"型刀 90° "V"GROOVING BIT	3/8"
90° "V"型刀 90° "V"GROOVING BIT	1/2"
子口荀刀 DOVETAIL BIT	1/2"
子口荀刀 DOVETAIL BIT	9/16"
圆底刀 CORE BOX BIT	R1/8"
圆底刀 CORE BOX BIT	R3/16"
圆底刀 CORE BOX BIT	R1/4"
单节刀 PANEL PILOT BIT	1/4"
修边刀 BEARING FLUSH TRIM BIT	3/8"×1/2"
修边刀 BEARING FLUSH TRIM BIT	3/8"×1
修边刀 BEARING FLUSH TRIM BIT	1/2"×1/2"
修边刀 BEARING FLUSH TRIM BIT	1/2"×1"
修边刀 BEARING FLUSH TRIM BIT	3/4"×3/4"
槽口刀 SLOT CUTTER BIT	1/4"
槽口刀 SLOT CUTTER BIT	5/16"
槽口刀 SLOT CUTTER BIT	3/8"
槽口刀 SLOT CUTTER BIT	1/2"
45° 斜角刀 45° CHAMFER BIT	3/8"
45° 斜角刀 45° CHAMFER BIT	1/2"
45° 斜角刀 45° CHAMFER BIT	5/8"
45° 斜角刀 45° CHAMFER BIT	3/4"
圆角刀 BEADING ROUNDING OVER BIT	R1/4"
圆角刀 BEADING ROUNDING OVER BIT	R3/8"
圆角刀 BEADING ROUNDING OVER BIT	R1/2"
敏仔刀 ROUNDING OVER BIT	R1/4"
敏仔刀 ROUNDING OVER BIT	R3/8"
敏仔刀 ROUNDING OVER BIT	R1/2"
倒角刀 ROUNDING COVE BIT	R1/4"
倒角刀 ROUNDING COVE BIT	R3/8"
倒角刀 ROUNDING COVE BIT	R1/2"
卢西线刀 ROMAN OGEE BIT	R5/32"
卢西线刀 ROMAN OGEE BIT	R7/32"
卢西线刀 ROMAN OGEE BIT	R9/32"
跳桌角线刀 OGEE PANEL BIT	R1/4"
跳桌角线刀 OGEE PANEL BIT	R3/8"
平角弧线刀 OGEE FLUTE BIT	R3/16"
凸敏仔线刀 CLASSIC COVE BIT	R5/16"
三弧桌刀 WAVY EDGE BIT	R3/16"
跳桌刀 CLASSICAL BIT	R3/16"
跳桌刀 CLASSICAL BIT	R1/4"
门斗条线刀 DOUBLE OGEE PANEL BIT	R1/8"
门斗条线刀 DOUBLE OGEE PANEL BIT	R3/16"
门斗条线刀 DOUBLE OGEE PANEL BIT	R1/4"



ROUTER BITS

Router bits choose special and high-quality material to manufacture. Patterns of standard products have two hundred varieties and over, with three thousand varieties of specifications, you can choose any variety. Through bits with different patterns and different specifications fit together each other, it can make kinds of exquisite board lines to meet every professional's different needs. You can buy them according to the serial number for catalogue or according to practical design demands.

FANNGOODER HOLDING



Router bits choose special and high-quality material to manufacture. Patterns of standard products have two hundred varieties and over, with three thousand varieties of specifications, you can choose any variety. Through bits with different patterns and different specifications fit together each other, it can make kinds of exquisite board lines to meet every professional's different needs. You can buy them according to the serial number for catalogue or according to practical design demands.

01 单刃直刀

STRAIGHT BIT

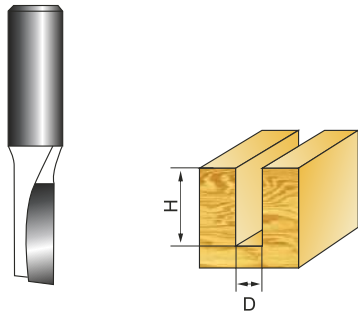

Part No.	Size	Z	D	H
FD01001	1/4 × 3/32	1	2.38	15
FD01002	1/4 × 1/8	1	3.17	15
FD01003	1/4 × 5/32	1	3.96	15
FD01004	1/4 × 3/16	1	4.76	15
FD01005	1/4 × 1/4	1	6.35	20
FD01006	1/4 × 5/16	1	7.96	20
FD01007	1/2 × 1/8	1	9.5	15
FD01008	1/2 × 5/32	1	3.96	15
FD01009	1/2 × 3/16	1	4.76	15

02 双刃直刀

STRAIGHT BIT

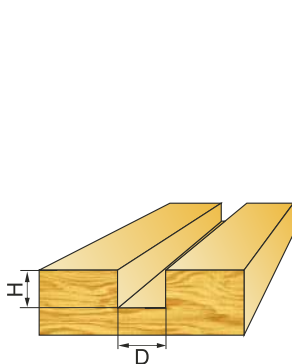

Part No.	Size	Z	D	H
FD02001	1/4 × 1/4	2	6.35	20
FD02002	1/4 × 5/16	2	7.96	20
FD02003	1/4 × 3/8	2	9.52	25
FD02004	1/4 × 1/2	2	12.7	25
FD02005	1/4 × 5/8	2	15.9	20
FD02006	1/4 × 3/4	2	19.05	20
FD02007	1/4 × 7/8	2	22.2	20
FD02008	1/4 × 1	2	25.4	20
FD02017	1/2 × 1-1/8	2	28.6	30
FD02018	1/2 × 1-1/4	2	31.75	30
FD02019	1/2 × 1-3/8	2	34.9	30
FD02020	1/2 × 1-1/2	2	38.1	30
FD02021	1/2 × 1-3/4	2	44.5	30
FD02022	1/2 × 2	2	50.8	30

03 加长直刀

LONG BLADE STRAIGHT BIT

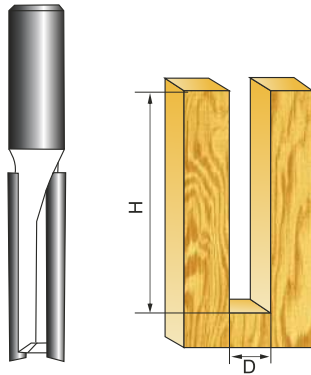

Part No.	Size	Z	D	H
FD03001	1/4 × 1/4 × 1-1/4	2	6.35	31.75
FD03002	1/4 × 1/4 × 1-1/2	2	6.35	38.10
FD03003	1/4 × 3/8 × 1-1/4	2	9.52	31.75
FD03004	1/4 × 3/8 × 1-1/2	2	9.52	38.10
FD03005	1/4 × 3/8 × 2	2	9.52	50.80
FD03006	1/4 × 3/8 × 2-1/2	2	9.52	63.50
FD03007	1/4 × 1/2 × 1-1/4	2	12.7	31.75
FD03008	1/4 × 1/2 × 1-1/2	2	12.7	38.10
FD03009	1/4 × 1/2 × 2	2	12.7	50.80
FD03013	1/2 × 1/2 × 2-1/2	2	12.7	63.50
FD03014	1/2 × 1/2 × 3	2	12.7	76.20
FD03015	1/2 × 3/8 × 2	2	9.52	50.80
FD03016	1/2 × 3/8 × 2-1/2	2	9.52	63.50
FD03017	1/2 × 3/8 × 3	2	9.52	76.20
FD03018	1/2 × 5/8 × 2-1/2	2	15.9	63.50

04 加长修边刀

BEARING FLUSH TRIM BIT

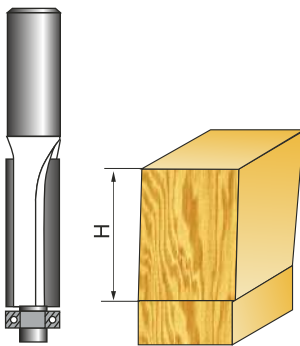

Part No.	Size	D	H
FD04001	1/4 × 1/4 × 1-1/2	7.00	38.0
FD04002	1/4 × 3/8 × 1-1/2	9.50	38.0
FD04003	1/4 × 3/8 × 2	9.50	50.8
FD04004	1/4 × 3/8 × 2-1/2	9.50	63.5
FD04005	1/4 × 3/8 × 3	9.50	76.2
FD04006	1/2 × 1/2 × 1-1/2	12.70	38.0
FD04007	1/2 × 1/2 × 2	12.70	50.8
FD04008	1/2 × 1/2 × 2-1/2	12.70	63.5
FD04009	1/2 × 1/2 × 3	12.70	76.2

05 修边刀

BEARING FLUSH TRIM BIT

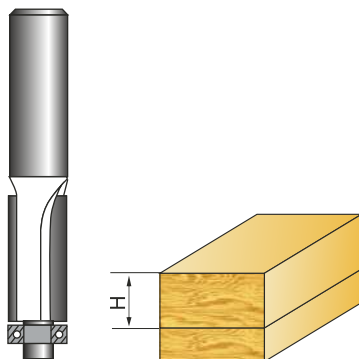

Part No.	Size	D	H
FD05001	1/4 × 1/4	7.00	20
FD05002	1/4 × 5/16	8.00	20
FD05003	1/4 × 3/8	9.50	25
FD05004	1/4 × 1/2	12.70	25

06 圓底刀

COVE BOX BIT

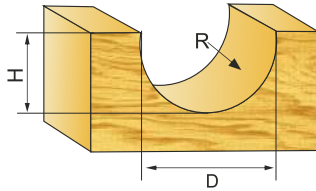
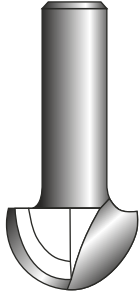

Part No.	Size	D	R	H
FD06003	1/4 × 1/4	6.35	3.17	6.35
FD06004	1/4 × 5/16	7.96	3.96	6
FD06005	1/4 × 3/8	9.52	4.76	7.5
FD06006	1/4 × 1/2	12.7	6.35	∅.4
FD06007	1/4 × 5/8	15.9	7.95	10
FD06008	1/4 × 3/4	19.05	9.52	12
FD06009	1/4 × 7/8	22.2	11.1	13.5
FD06010	1/4 × 1	25.4	12.7	15.0

07 圓角刀

CORNER ROUND BIT

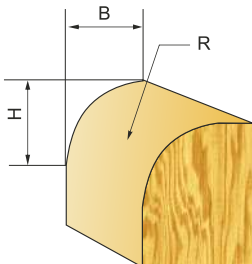
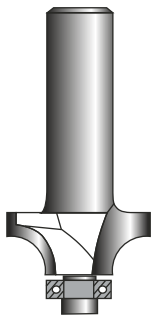

Part No.	Size	D	R	B	H
FD07001	1/4x3/16	17.46	2.38	2.38	6.5
FD07002	1/4x1/4	19.05	3.17	3.17	7.0
FD07003	1/4x5/16	20.62	3.96	3.97	8.0
FD07004	1/4x3/8	22.22	4.76	4.76	9.0
FD07005	1/4x1/2	25.4	6.35	6.35	11.0
FD07006	1/4x5/8	28.6	7.96	7.96	12.7
FD07007	1/4x3/4	31.7	9.52	9.52	15.9
FD07008	1/4x7/8	34.9	11.1	11.1	17
FD07009	1/4x1	38.1	12.7	12.7	19.05
FD07019	1/2 × 1-1/8	41.3	14.3	14.29	19.3
FD07020	1/2 × 1-1/4	44.45	15.9	15.9	22.2
FD07021	1/2 × 1-3/8	47.60	17.45	17.46	23.85
FD07022	1/2 × 1-1/2	50.8	19.05	19.05	25.4
FD07023	1/2 × 1-5/8	53.96	20.63	20.64	27.13
FD07024	1/2 × 1-3/4	57.15	22.2	22.23	28.5
FD07025	1/2 × 1-7/8	60.32	23.81	23.81	30.31
FD07026	1/2 × 2	63.5	25.4	25.4	32
FD07027	1/2 × 2-1/8	66.66	26.98	26.98	33.48
FD07030	1/2 × 2-1/2	76.2	31.75	31.75	38.25
FD07031	1/2 × 2-5/8	79.37	33.33	33.33	39.83
FD07032	1/2 × 2-3/4	82.55	34.92	34.93	41.42
FD07033	1/2 × 2-7/8	85.72	36.51	36.51	43.01
FD07034	1/2 × 3	88.9	38.1	38.1	45.1

ROUTER BITS



09 T型刀

"T"TYPE SLOTTING CUTTER

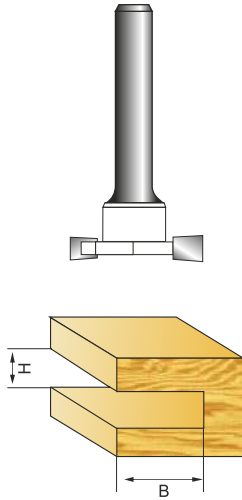

Part No.	Size	D	H	B
FD09001	1/4 × 3/32	31.5	2.38	8.4
FD09002	1/4 × 1/8	31.5	3.17	8.4
FD09003	1/4 × 5/32	31.5	3.96	8.4
FD09004	1/4 × 3/16	31.5	4.76	8.4
FD09005	1/4 × 1/4	31.5	6.35	8.4
FD09006	1/4 × 5/16	31.5	7.96	8.4
FD09007	1/4 × 3/8	31.5	9.52	8.4
FD09008	1/4 × 1/2	31.5	12.7	8.4
FD09009	1/4 × 5/8	31.5	15.9	8.4
FD09019	1/2 × 3/4	31.5	19.1	8.4
FD09020	1/2 × 7/8	31.5	22.2	8.4
FD09021	1/2 × 1	31.5	25.4	8.4

10 45°斜角刀

45° CHAMFER BIT

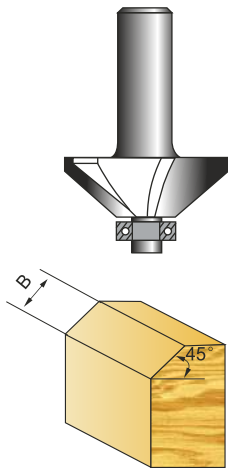

Part No.	Size	D	α	B
FD10001	1/4 × 1/4	21.98	45°	6.35
FD10002	1/4 × 5/16	24.25	45°	7.92
FD10003	1/4 × 3/8	26.50	45°	9.52
FD10004	1/4 × 1/2	30.96	45°	12.7
FD10005	1/4 × 5/8	35.50	45°	15.9
FD10006	1/4 × 3/4	40.00	45°	19.05
FD10007	1/4 × 7/8	44.40	45°	22.2
FD10008	1/4 × 1	48.90	45°	25.4
FD10017	1/2 × 1-1/8	53.40	45°	28.6
FD10018	1/2 × 1-1/4	57.90	45°	31.75
FD10019	1/2 × 1-3/8	62.40	45°	34.9
FD10020	1/2 × 1-1/2	67.00	45°	38.10

12 V型刀

"V" GROOVING BIT

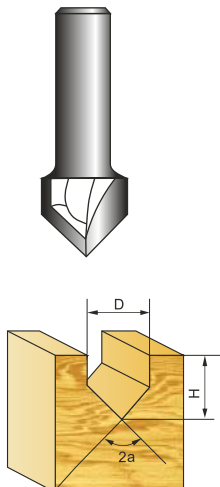

Part No.	Size	D	H	2 α
FD12001	1/4 × 1/4	6.35	6.35	90°
FD12002	1/4 × 5/16	7.96	7.96	90°
FD12003	1/4 × 3/8	9.52	9.52	90°
FD12004	1/4 × 1/2	12.7	12.7	90°
FD12005	1/4 × 5/8	15.9	15.9	90°
FD12006	1/4 × 3/4	19.05	17.5	90°
FD12007	1/4 × 7/8	22.2	22.2	90°
FD12008	1/4 × 1	25.4	25.4	90°

13 深圆底刀

ROUND NOSE BIT

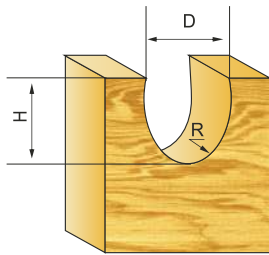
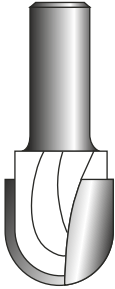

Part No.	Size	D	H	R
FD13019	1/4×5/16	7.9	15.9	4
FD13001	1/4×3/8	9.52	19.6	4.76
FD13002	1/4×1/2	12.7	19.6	6.35
FD13003	1/4×5/8	15.9	19.6	7.96
FD13004	1/4×3/4	19.05	19.6	9.52
FD13005	1/4×7/8	22.2	21.5	11.1
FD13006	1/4×1	25.4	22.5	12.7

14 滚珠T型刀

"T"TYPE BIT WITH BEARING

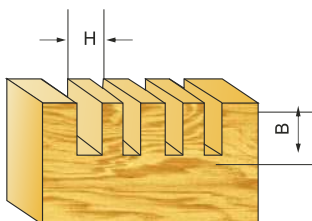
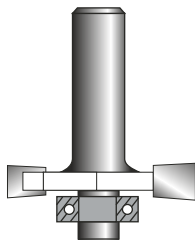

Part No.	Size	D	H	B
FD14001	1/4×3/32	31.75	2.38	8.4
FD14002	1/4×1/8	31.75	3.17	8.4
FD14003	1/4×5/32	31.75	3.96	8.4
FD14004	1/4×3/16	31.75	4.76	8.4
FD14005	1/4×1/4	31.75	6.35	8.4
FD14006	1/4×5/16	31.75	7.96	8.4
FD14007	1/4×3/8	31.75	9.52	8.4
FD14008	1/4×1/2	31.75	12.7	8.4
FD14017	1/2×5/8	31.75	15.9	8.4
FD14018	1/2×3/4	31.75	19.05	8.4
FD14019	1/2×7/8	31.75	22.2	8.4
FD14020	1/2×1	31.75	25.4	8.4

15 敏仔刀

BEADING BITS

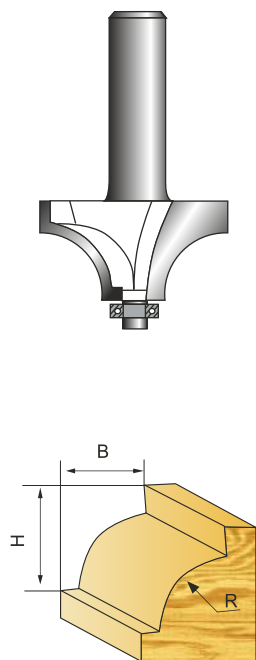

Part No.	Size	D	R	B	H
FD15001	1/4 × 1/8	15.9	1.58	3.45	5.3
FD15002	1/4 × 3/16	17.46	2.38	4.23	6.5
FD15003	1/4 × 1/4	19.05	3.17	5.02	7.0
FD15004	1/4 × 5/16	20.62	3.96	5.81	8.0
FD15005	1/4 × 3/8	22.22	4.76	6.61	9.0
FD15006	1/4 × 1/2	25.4	6.35	8.2	11.0
FD15007	1/4 × 5/8	28.6	7.96	9.8	12.7
FD15008	1/4 × 3/4	31.7	9.52	11.35	15.9
FD15009	1/4 × 7/8	34.9	11.1	12.9	17
FD15010	1/4 × 1	38.1	12.7	14.5	19.05
FD15019	1/2 × 1-1/8	41.3	14.3	16.15	19.3
FD15020	1/2 × 1-1/4	44.45	15.9	17.72	22.2
FD15021	1/2 × 1-3/8	47.60	17.45	19.3	23.85
FD15022	1/2 × 1-1/2	50.8	19.05	20.9	25.4
FD15023	1/2 × 1-5/8	53.96	20.63	22.48	27.13
FD15024	1/2 × 1-3/4	57.15	22.2	24.07	28.5
FD15025	1/2 × 1-7/8	60.32	23.81	25.66	30.31
FD15026	1/2 × 2	63.5	25.4	27.25	32
FD15027	1/2 × 2-1/8	66.66	26.98	28.83	33.48
FD15028	1/2 × 2-1/4	69.84	28.57	30.42	35.07
FD15029	1/2 × 2-3/8	73.02	30.16	32.01	36.66
FD15030	1/2 × 2-1/2	76.2	31.75	33.6	38.25
FD15031	1/2 × 2-5/8	79.37	33.33	35.18	39.83
FD15032	1/2 × 2-3/4	82.55	34.92	36.77	41.42
FD15033	1/2 × 2-7/8	85.72	36.51	38.36	43.01
FD15034	1/2 × 3	88.9	38.1	39.95	45.1

17 倒角刀

COVE BIT

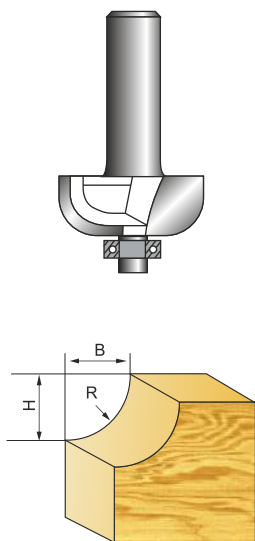

Part No.	Size	D	R	B	H
FD17005	1/4 × 3/8	22.5	4.76	4.76	7.8
FD17006	1/4 × 1/2	25.7	6.35	6.35	9.52
FD17007	1/4 × 5/8	28.9	7.96	7.96	10.3
FD17008	1/4 × 3/4	32.1	9.52	9.52	12.3
FD17009	1/4 × 7/8	35.2	11.1	11.1	14.5
FD17010	1/4 × 1	38.4	12.7	12.7	15.8
FD17019	1/2 × 1-1/8	41.6	14.3	14.3	18
FD17020	1/2 × 1-1/4	44.8	15.9	15.9	19.4
FD17021	1/2 × 1-3/8	47.9	17.45	17.45	21.0
FD17022	1/2 × 1-1/2	51.1	19.05	19.05	22.7

18 双边斗条线刀

CLASSICAL WITHOUT BEADING

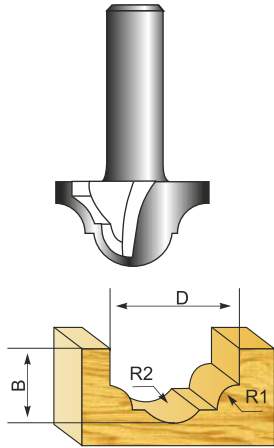

Part No.	Size	D	B	R1	R2
FD18001	1/4 × 1/2	12.7	11.1	3.17	3.17
FD18002	1/4 × 5/8	15.9	11.1	3.96	3.96
FD18003	1/4 × 3/4	19.1	12.7	4.76	4.76
FD18004	1/4 × 7/8	22.2	12.9	4.76	5.55
FD18005	1/4 × 1	25.4	17.46	4.76	6.35

19 开口雕刻刀

OPEN END CARVING BIT

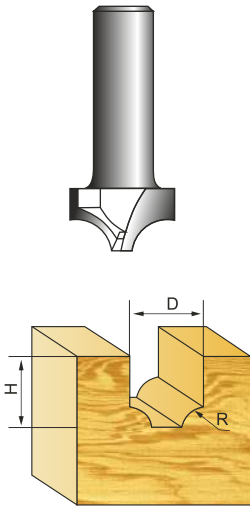

Part No.	Size	D	H	R
FD19001	1/4 × 1/4	6.35	2.38	6.40
FD19002	1/4 × 5/16	7.96	2.77	7.96
FD19003	1/4 × 3/8	9.52	3.17	9.50
FD19004	1/4 × 1/2	12.7	6.35	10.0
FD19005	1/4 × 5/8	15.9	7.95	11.0
FD19006	1/4 × 3/4	19.05	9.52	11.8
FD19007	1/4 × 7/8	22.2	11.1	13.3
FD19008	1/4 × 1	25.4	12.7	13.5

20 尖嘴雕刻刀

CARVING BIT

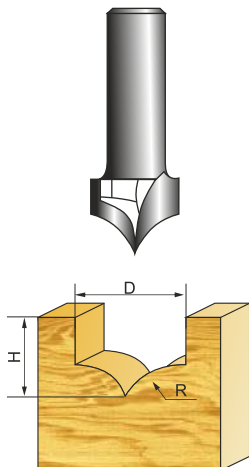

Part No.	Size	D	H	R
FD20001	1/4 × 1/4	6.35	3.17	7.5
FD20002	1/4 × 5/16	7.96	3.96	8.1
FD20003	1/4 × 3/8	9.52	4.76	8.77
FD20004	1/4 × 1/2	12.7	6.35	10.02
FD20005	1/4 × 5/8	15.9	7.96	11.3
FD20006	1/4 × 3/4	19.05	9.52	14.0
FD20007	1/4 × 7/8	22.2	11.1	15.2
FD20008	1/4 × 1	25.4	12.7	16.5

26 半圆刀

HALF ROUND SIDE CUTTER BIT

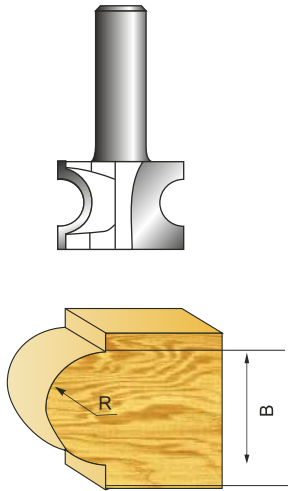

Part No.	Size	D	R	B
FD26001	1/4 × 1/4	23.5	3.17	6.35
FD26002	1/4 × 5/16	25.0	3.96	7.93
FD26003	1/4 × 3/8	26.5	4.76	9.52
FD26004	1/4 × 1/2	29.5	6.35	12.7
FD26005	1/4 × 5/8	33.0	7.96	15.9
FD26006	1/4 × 3/4	36.0	9.52	19.05
FD26007	1/4 × 7/8	39.2	11.1	22.2
FD26008	1/4 × 1	42.4	12.7	25.4

28 凸敏仔线刀

CLASSICAL COVE BIT

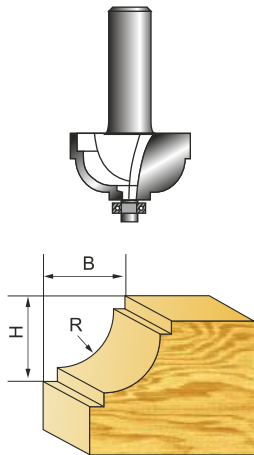

Part No.	Size	D	R	B	H
FD28018	1/4 × 1/4	19	3	3.17	7.5
FD28019	1/4 × 5/16	22	3.5	3.95	9.5
FD28001	1/4 × 3/8	24.9	4.76	7.95	12.7
FD28002	1/4 × 1/2	28.1	6.35	9.55	15.9
FD28003	1/4 × 5/8	31.22	7.96	11.1	17.5

29 框架线刀

DOUBLE ROMAN OGEE BIT

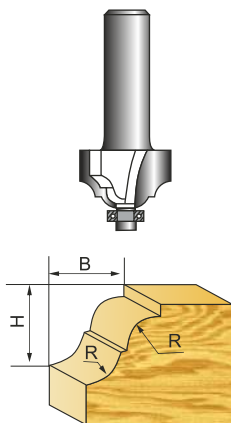

Part No.	Size	D	R	B	H
FD29001	1/4 × 1/2	21.68	3.17	6.35	12.7
FD29002	1/4 × 5/8	24.9	3.96	7.95	15.9
FD29003	1/4 × 3/4	28.04	4.76	9.52	19.0
FD29004	1/4 × 7/8	31.2	5.55	11.1	20.63
FD29005	1/4 × 1	34.4	6.35	12.70	22.2

30 双R线刀

CLASSICAL MOULDING BIT

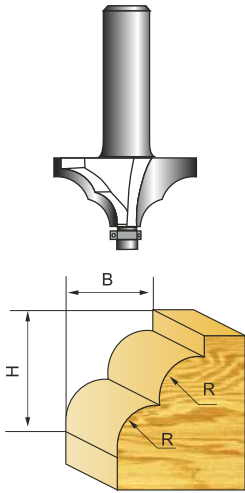

Part No.	Size	D	R	B	H
FD30001	1/4 × 1/4	19.35	1.58	3.17	6.16
FD30002	1/4 × 5/16	20.93	1.98	3.96	7.13
FD30003	1/4 × 3/8	22.5	2.38	4.76	7.93
FD30004	1/4 × 1/2	25.7	3.17	6.35	9.52
FD30005	1/4 × 5/8	28.9	3.96	7.95	12.7
FD30006	1/4 × 3/4	32.5	4.76	9.52	14.3
FD30007	1/4 × 7/8	35.2	5.55	11.1	15.76
FD30008	1/4 × 1	38.4	6.35	12.7	17.5

31 户西线刀

ROMAN OGEE BIT WITH BEARING

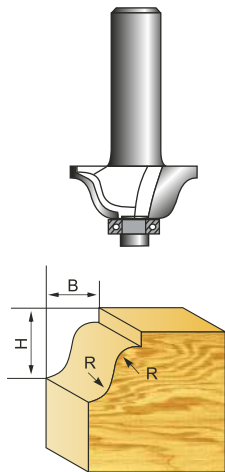

Part No.	Size	D	R	B	H
FD31001	1/4 × 3/8	22.5	2.38	4.76	8.0
FD31002	1/4 × 1/2	25.7	3.17	6.35	9.7
FD31003	1/4 × 5/8	28.9	3.96	7.95	11.5
FD31004	1/4 × 3/4	32	4.76	9.52	14.0
FD31005	1/4 × 7/8	35.2	5.6	11.1	15.7
FD31006	1/4 × 1	38.2	6.35	12.7	18.2
FD31013	1/2 × 1-1/8	41.6	7.14	14.3	18.7
FD31014	1/2 × 1-1/4	44.7	7.95	15.9	22.2
FD31015	1/2 × 1-3/8	47.92	8.73	17.46	23.46
FD31016	1/2 × 1-1/2	51.1	9.52	19.05	25.5
FD31017	1/2 × 1-5/8	54.27	10.31	20.63	27.0
FD31018	1/2 × 1-3/4	57.48	11.1	22.2	28.3
FD31019	1/2 × 2	63.8	12.7	25.4	31.8

32 跳卓角线刀

CURVED LINE BIT

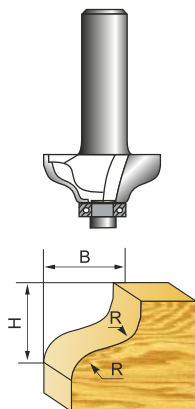

Part No.	Size	D	R	B	H
FD32001	1/4 × 1/2	25.7	3.52	6.35	13
FD32002	1/4 × 5/8	28.9	4.59	7.95	15.1
FD32003	1/4 × 3/4	32	5.74	9.5	17.3
FD32004	1/4 × 7/8	35.2	7.00	11.1	19.7
FD32005	1/4 × 1	38.4	8.41	12.7	22.3

33 平角弧线刀

CLASSICAL BIT

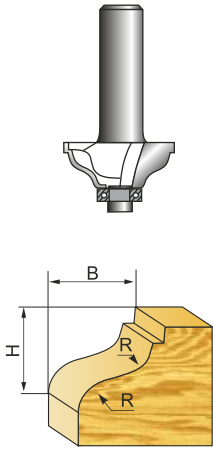

Part No.	Size	D	R	B	H
FD33001	1/4 × 1/2	25.69	2.38	6.34	9.52
FD33002	1/4 × 5/8	28.85	3.17	7.92	11.1
FD33003	1/4 × 3/4	32.02	3.96	9.52	12.9
FD33004	1/4 × 7/8	35.21	4.76	11.1	14.3
FD33005	1/4 × 1	38.57	5.60	12.7	15.9
FD33011	1/2 × 1-1/8	41.57	6.35	14.28	17.5

34 三弧桌刀

WAVY EDGE BIT

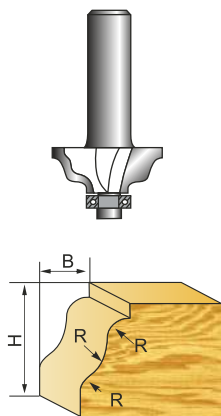

Part No.	Size	D	R	B	H
FD34001	1/4 × 1/2	25.7	3.17	6.35	12.7
FD34002	1/4 × 5/8	28.84	3.96	7.92	15.9
FD34003	1/4 × 3/4	32.05	3.96	9.52	17.46
FD34004	1/4 × 7/8	35.2	4.76	11.1	20.0
FD34005	1/4 × 1	38.4	5.55	12.7	22.2
FD34011	1/2 × 1-1/8	41.6	6.35	14.3	25.4

37 双珠饰刀

DOUBLE BEADING BIT

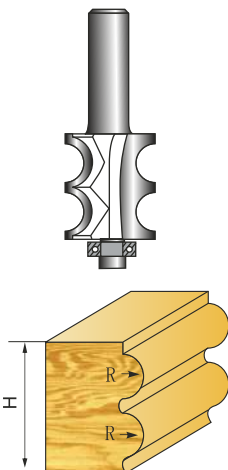

Part No.	Size	D	R	H
FD37001	1/4 × 1/4	22.2	3.17	19.05
FD37002	1/4 × 5/16	23.86	3.96	22.98
FD37003	1/4 × 3/8	25.4	4.76	26.18
FD37007	1/2 × 1/2	28.6	6.35	34.4
FD37008	1/2 × 5/8	31.8	7.96	40.8
FD37009	1/2 × 3/4	34.94	9.52	47.1

38 门斗条线刀

CLASSICAL BIT

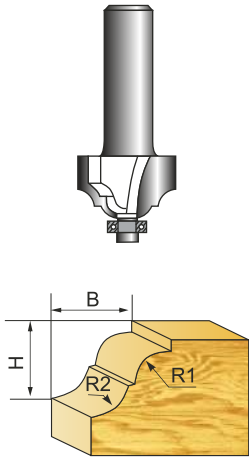

Part No.	Size	D	R1	R2	B	H
FD38001	1/4×3/8	27.51	2.38	3.17	7.25	10
FD38002	1/4×1/2	31.7	3.17	4.79	9.35	12.7
FD38003	1/4×5/8	39.28	4.79	6.35	13.14	15.9
FD38004	1/4×3/4	46.04	6.35	7.9	16.52	19.05
FD38005	1/4×7/8	51.8	7.9	9.5	19.4	22.2
FD38006	1/4×1	60.3	9.5	11.1	23.65	25.6
FD38013	1/2×1-1/8	64.6	11.1	12.7	25.8	28.6

39 三珠饰刀

MULTI-BEADING BIT

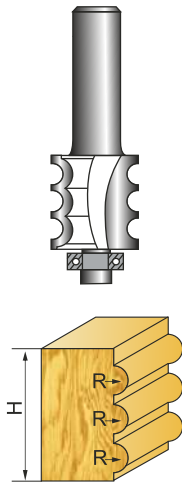

Part No.	Size	D	R	H
FD39001	1/4×7/8	20.66	2.38	22.5
FD39002	1/4×1	22.2	3.17	25.4
FD39005	1/2×1-1/8	23.02	3.56	28.6
FD39006	1/2×1-1/4	23.82	3.96	31.75
FD39007	1/2×1-5/8	24.62	4.36	24.9
FD39008	1/2×1-7/16	25.42	4.76	36.51

40 一条线刀

DRAWING LINE BIT

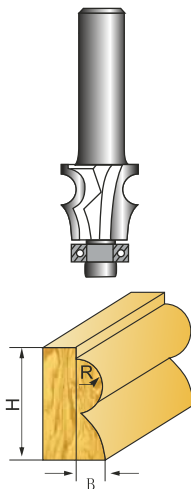

Part No.	Size	D	R	B	H
FD40001	1/4×3/16	21.8	2.38	3.4	22
FD40002	1/4×1/4	22.8	3.17	3.9	22
FD40003	1/4×5/16	22.8	3.96	3.9	22
FD40004	1/4×3/8	24	4.76	4.5	22
FD40009	1/4×1/2	25	6.35	5.5	22

42 桌缘刀

TABLE EDGE BIT

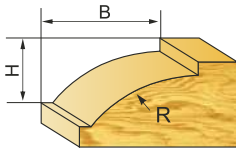
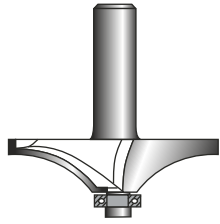

Part No.	Size	D	R	B	H
FD42001	1/4 × 3/8	30.16	11.9	10.58	9.5
FD42003	1/2 × 1/2	51.1	23.85	21.05	12.7
FD42004	1/2 × 5/8	69.85	44.45	28.42	15.9

45 圆角敏仔刀

TABLE CORNER BIT

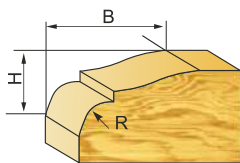
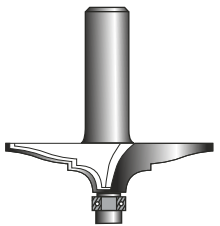

Part No.	Size	D	R	H	B
FD45001	1/4 × 3/8	32.80	2.38	9.52	11.9
FD45003	1/2 × 1/2	40.75	3.17	12.7	15.8
FD45004	1/2 × 5/8	50.27	4.76	15.9	20.63

46 户西门板线刀

RAISED PANEL BIT

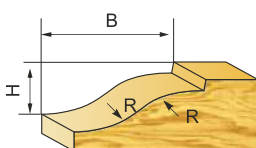
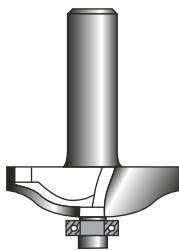

Part No.	Size	D	R	B	H
FD46003	1/4 × 5/8	44.75	11.1	15.87	12.7
FD46004	1/4 × 3/4	51.1	12.7	19.05	15.9
FD46009	1/2 × 7/8	57.4	15.9	22.2	15.9
FD46010	1/2 × 1	63.8	15.9	25.4	15.9
FD46011	1/2 × 1-1/6	66.9	17.46	26.95	15.9
FD46012	1/2 × 1-1/8	70.2	19.05	28.6	15.9
FD46013	1/2 × 1-1/4	76.5	19.05	31.75	15.9
FD46014	1/2 × 1-7/16	86	22.2	36.5	15.9
FD46015	1/2 × 1-1/2	89.2	22.5	38.1	15.9

47 手把丸刀

ROUND CARVING BIT

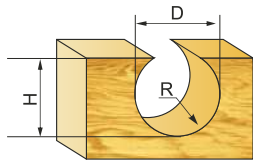
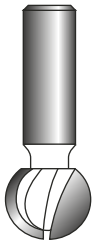

Part No.	Size	D	R	H
FD47001	1/4 × 3/8	12.7	4.76	9.52
FD47002	1/4 × 1/2	15.9	6.35	12.7
FD47003	1/4 × 5/8	19.05	7.96	15.9
FD47004	1/4 × 3/4	22.2	9.52	19.05
FD47005	1/4 × 7/8	25.4	11.1	22.2
FD47006	1/4 × 1	28.6	12.7	25.4

48 凸圆门斗刀

HANDRAIL CLASSICAL BIT

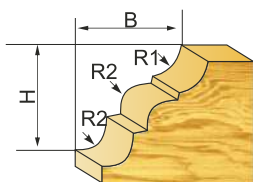
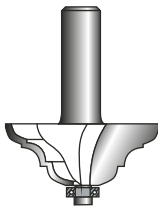

Part No.	Size	D	R1	R2	B	H
FD48001	1/4 × 1/2	34.4	3.96	3.17	12.7	12.7
FD48003	1/2 × 5/8	40.8	4.8	3.96	15.9	15.9
FD48004	1/2 × 3/4	47.1	7.13	5.55	19.05	19.05
FD48005	1/2 × 7/8	53.44	7.14	6.35	22.2	22.2

49 1/4丸球刀

1/4 ROUND CARVING BIT

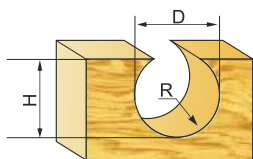
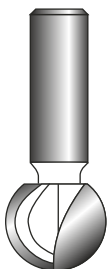

Part No.	Size	D	R	H
FD49001	1/4 × 3/8	9.52	4.76	8.26
FD49002	1/4 × 1/2	12.7	6.35	11.82
FD49003	1/4 × 5/8	15.9	7.96	15.23
FD49004	1/4 × 3/4	19.05	9.52	18.43
FD49005	1/4 × 7/8	22.2	11.1	21.72
FD49006	1/4 × 1	25.4	12.7	24.98

51 凸圆刀

ARCH TYPE ROUTER BIT

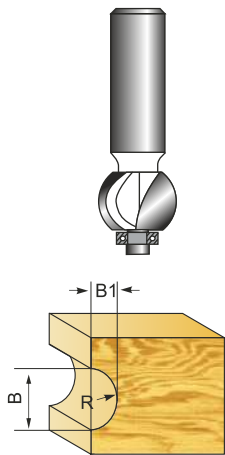

Part No.	Size	D	R1	B	B1
FD51001	1/4 × 1/4	20.0	3.25	6.35	2.5
FD51002	1/4 × 5/16	22.2	3.97	7.96	3.6
FD51003	1/4 × 3/8	22.2	4.94	9.52	3.6
FD51004	1/4 × 1/2	22.2	7.4	12.7	3.6
FD51005	1/4 × 5/8	24.0	9.27	15.9	4.5
FD51006	1/4 × 3/4	25.4	11.32	19.05	5.2
FD51007	1/4 × 7/8	26.4	13.65	22.2	5.7
FD51008	1/4 × 1	26.4	16.99	25.4	5.7

54 清弧刀

TRIM BIT

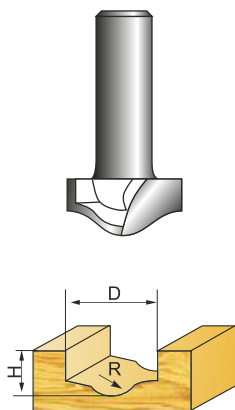

Part No.	Size	D	R	H
FD54001	1/4 × 3/4	19.05	6.35	10.5
FD54002	1/4 × 7/8	22.2	7.14	11.7
FD54003	1/4 × 1	25.4	7.9	12.7
FD54004	1/4 × 1-1/8	28.6	9.5	14.3

56 双边双R线刀 (没有轴承作导向)

CLASSICAL MOULDING BIT WITHOUT BEARING

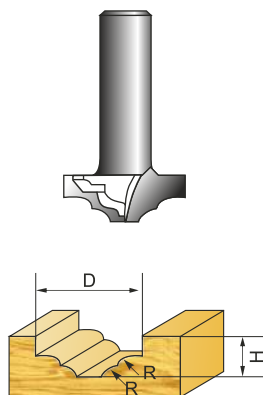

Part No.	Size	D	R	H
FD56001	1/4 × 1/2	17.5	3.17	11.1
FD56002	1/4 × 5/8	20.6	3.96	13.7
FD56003	1/4 × 3/4	23.8	4.76	14.3
FD56004	1/4 × 7/8	26.96	5.55	15.9
FD56005	1/4 × 1	30.16	6.35	17.5

57 双边平角弧线刀 (没有轴承作导向) CLASSICAL BIT WITHOUT BEARING

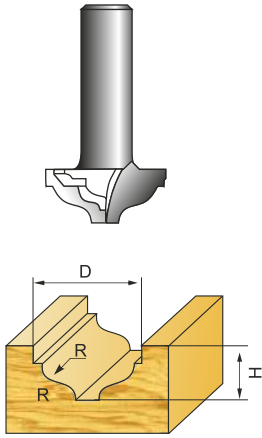

Part No.	Size	D	R	H
FD57001	1/4 × 1/2	17.45	2.38	9.52
FD57002	1/4 × 5/8	20.61	3.17	11.1
FD57003	1/4 × 3/4	23.78	3.96	12.9
FD57004	1/4 × 7/8	26.97	4.76	14.3
FD57005	1/4 × 1	30.33	5.60	15.9

59 双边框架线 (没有轴承作导向) DOUBLE ROMAN OGEE BIT WITHOUT BEARING

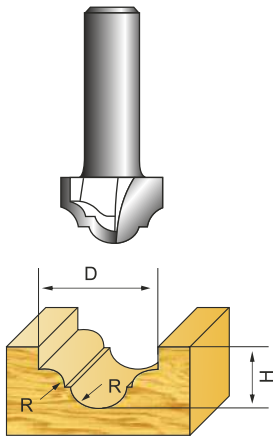

Part No.	Size	D	R	H
FD59001	1/4 × 1/2	19.05	3.17	11.1
FD59002	1/4 × 5/8	22.19	3.96	13.0
FD59003	1/4 × 3/4	25.4	4.76	14.3
FD59004	1/4 × 7/8	28.6	5.55	15.0
FD59005	1/4 × 1	31.75	6.35	17.5

60 双边户西线刀 (没有轴承作导向) ROMAN OGEE BIT WITHOUT BEARING

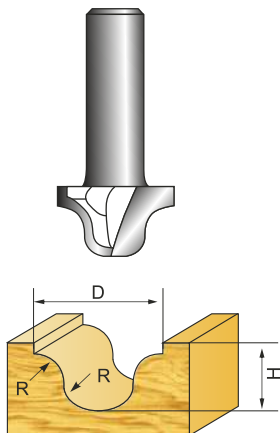

Part No.	Size	D	R	H
FD60001	1/4 × 3/8	12.7	2.38	8.0
FD60002	1/4 × 1/2	15.9	3.17	9.5
FD60003	1/4 × 5/8	19.1	3.96	11.1
FD60004	1/4 × 3/4	22.2	4.76	14.0
FD60005	1/4 × 7/8	25.6	5.6	15.0
FD60006	1/4 × 1	30.16	6.35	17.0

72 凸边指甲刀

SIDE FINGER NAIL TYPE BIT

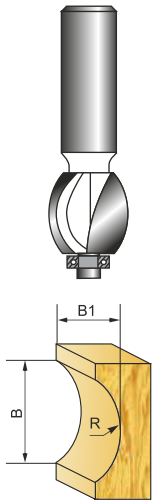

Part No.	Size	D	R	B ₁	B
FD72001	1/4 × 1/4	20.5	3.8	3.75	6.35
FD72002	1/4 × 5/16	20.5	3.98	3.75	7.96
FD72003	1/4 × 3/18	20.5	4.89	3.75	9.52
FD72004	1/4 × 1/2	20.5	7.25	3.75	12.7
FD72005	1/4 × 5/8	20.5	10.30	3.75	15.9
FD72006	1/4 × 3/4	20.4	10.41	6.20	19.05
FD72007	1/4 × 7/8	20.4	13.03	6.20	22.2
FD72008	1/4 × 1	20.5	16.10	6.20	25.4

74 开榫刀

MORTISING BIT

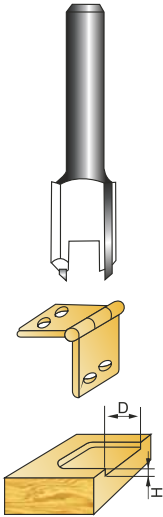

Part No.	Size	D	H
FD74001	1/4 × 1/2	12.70	19.05
FD74002	1/4 × 5/8	15.90	19.05
FD74003	1/4 × 3/4	19.05	19.05
FD74007	1/2 × 7/8	22.20	19.05
FD74008	1/2 × 1	25.40	19.05

77 子口苟刀

DOVETAIL BIT

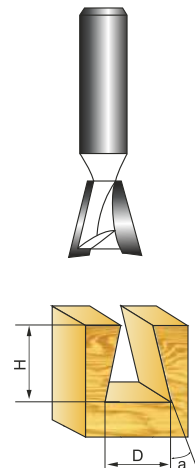

Part No.	Size	D	a	H
FD77001	1/4 × 3/8	9.52	8°	10
FD77002	1/4 × 1/2	12.70	8°	13
FD77003	1/4 × 5/8	15.90	14°	16
FD77004	1/4 × 3/4	19.05	14°	20
FD77005	1/4 × 7/8	22.20	14°30'	23
FD77006	1/4 × 1	25.40	14°30'	26

79 25°清底刀

ROUTER BIT

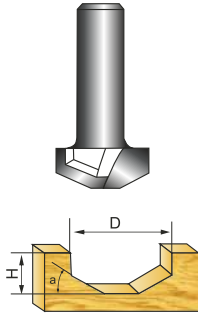

Part No.	Size	D	a	H
FD79003	1/4×3/8	23.16	25°	9.52

80 跳桌刀

CLASSICAL OGEE BIT

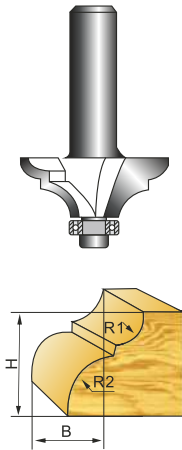

Part No.	Size	D	R1	R2	H	B
FD80001	1/4×3/4	32.05	3.17	6.35	12.70	9.52
FD80002	1/4×7/8	35.20	3.96	7.14	14.28	11.10
FD80003	1/4×1	38.40	4.76	7.93	15.90	12.70
FD80007	1/2×1-1/8	41.54	5.55	8.72	17.40	14.27
FD80008	1/2×1-1/4	44.75	6.35	9.52	19.04	15.87

89 S形榫合刀

STILE & RAIL ASSEMBLES-ROMAN OGEE

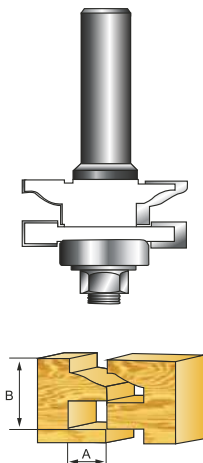

TWO FLUTES, BALL BEARING GUIDE(BEARING 22mm)

Part No.	A	B	C	D
FD89001	3/8	15/16	1/4	1-1/4
FD89002	3/8	15/16	1/2	1-37/64

93 户西榫合刀

RAIL & STILE SETS-ROMAN OGEE

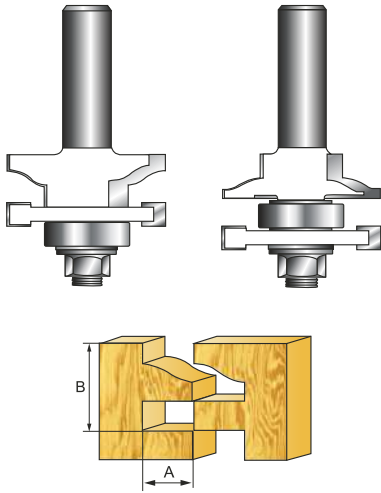

TWO FLUTES, BALL BEARING GUIDE(BEARING 22mm)

Part No.	A	B	C	D
FD93001	3/8	1	1/2	1-1/2

97 仿型直刀

IMITATED STRAIGHT BIT

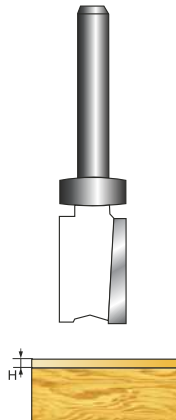

Part No.	Size	D	H
FD97001	1/4x1/2	12.7	25.4
FD97002	1/4x5/8	15.9	20
FD97003	1/4x3/4	19.05	20
FD97004	1/4x7/8	22.00	20
FD97005	1/4x1	25.4	20

99 仿型V型刀

IMITATED "V" TYPE SLOTTING CUTTER

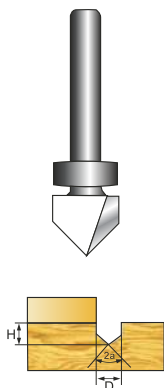

Part No.	Size	D	H	2a
FD99001	1/4x1/2	12.7	12.7	90°
FD99002	1/4x5/8	15.9	15.9	90°
FD99003	1/4x3/4	19.05	17.5	90°
FD99004	1/4x7/8	22.2	22.2	90°
FD99005	1/4x1	25.4	25.4	90°

102 仿型跳桌刀

IMITATED OGEE PANEL BIT

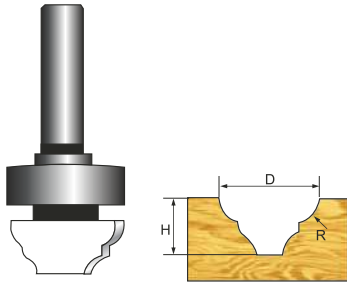

Part No.	Size	D	H	R
FD102001	1/4x7/8	22.2	9.52	2.38

103 仿型双边门斗刀

IMITATED DOUBLE CLASSICAL BIT

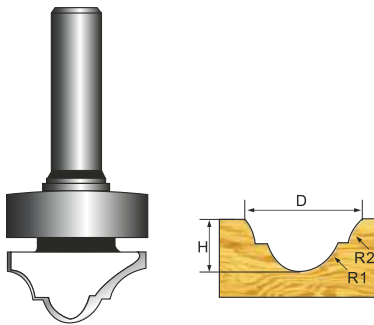

Part No.	Size	D	H	R1	R2
FD103001	1/4x1/2	12.7	11.1	3.17	3.17
FD103002	1/4x5/8	15.9	11.1	3.96	3.96
FD103003	1/4x3/4	19.1	12.7	4.76	4.76
FD103004	1/4x7/8	22.2	12.6	4.76	5.55
FD103005	1/4x1	25.4	17.46	4.76	6.35

104 仿型开口雕刻刀

IMITATED OPEN END CARVING BIT

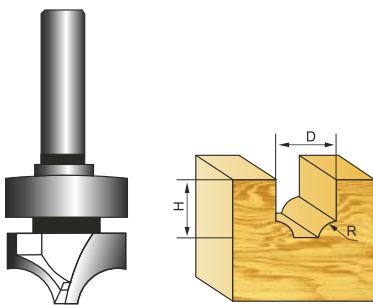

Part No.	Size	D	R	H
FD104001	1/4 x 1/2	12.7	6.35	10.0
FD104002	1/4 x 5/8	15.9	7.95	11.0
FD104003	1/4 x 3/4	19.05	9.52	11.8
FD104004	1/4 x 7/8	22.2	11.1	13.3
FD104005	1/4 x 1	25.4	12.7	13.5

105 仿型尖嘴雕刻刀

IMITATED CARVING BIT

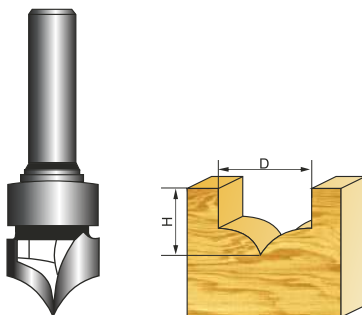

Part No.	Size	D	R	H
FD105001	1/4 x 1/2	12.7	6.35	10.02
FD105002	1/4 x 5/8	15.9	7.96	11.3
FD105003	1/4 x 3/4	19.05	9.52	14.0
FD105004	1/4 x 7/8	22.2	11.1	15.2
FD105005	1/4 x 1	25.4	12.7	16.5

ROUTER BITS

106 仿型S型雕刻刀

IMITATED CLASSICAL PLUNGE BIT

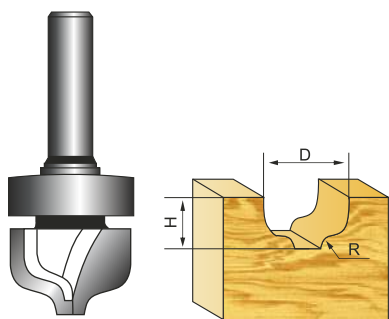

Part No.	Size	D	R	H
FD106001	1/4x1/2	12.7	1.98	9.5
FD106002	1/4x5/8	15.9	2.38	9.5
FD106003	1/4x3/4	19.1	3.2	11.1
FD106004	1/4x7/8	22.2	4.8	15.9
FD106005	1/4x1	25.4	4.8	17.5

107 仿型户西刀

IMITATED ROMAN OGEE BIT

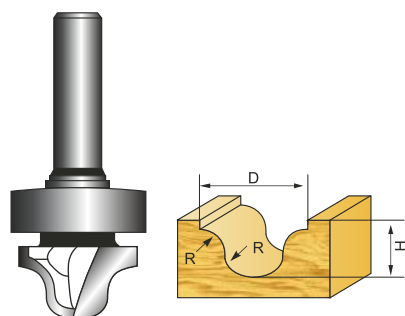

Part No.	Size	D	R	H
FD107001	1/4x1/2	15.9	3.17	9.5
FD107002	1/4x5/8	19.1	3.96	11.1
FD107003	1/4x3/4	22.2	4.76	14.0
FD107004	1/4x7/8	25.6	5.6	15.0

112 台阶圆弧刀

CLASSICAL BIT

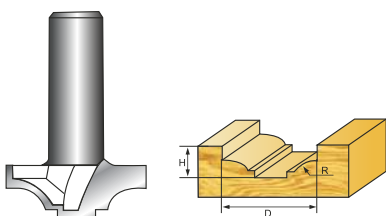

Part No.	Size	D	R	H
FD112001	1/4x3/8	25.40	4.76	8.50
FD112002	1/4x7/16	26.98	5.56	9.30
FD112003	1/4x1/2	28.60	6.35	10.10
FD112004	1/4x5/8	31.75	7.96	11.70

114 龙珠金圆刀

DRAGON BALL BIT

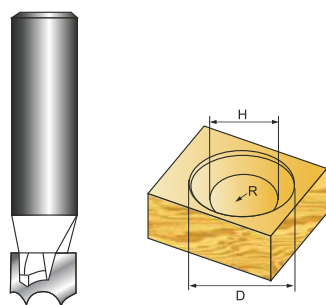

Part No.	Size	D	R	H
FD114003	1/4x3/8	15.50	5.26	9.52
FD114004	1/4x1/2	21.00	7.04	12.70
FD114005	1/4x5/8	26.00	8.82	15.90
FD114006	1/4x3/4	31.00	10.52	19.05
FD114013	1/2x7/8	34.00	12.30	22.20

116 元宝珠刀

DRAGON BALL BIT

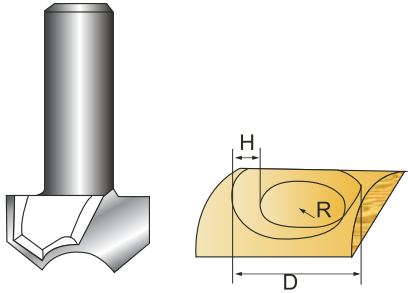

Part No.	Size	D	R	H
FD116004	1/4x1/2	30.00	7.94	3.17
FD116011	1/2x5/8	36.21	9.96	3.96

126 "T" 型組合刀

TONGUE & GROOVE ASSEMBLY BIT

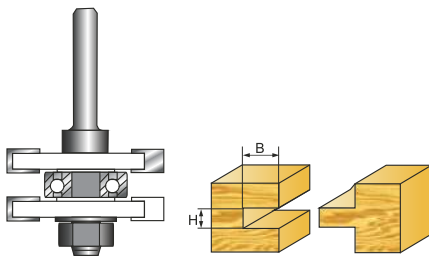

Part No.	D	H	B
FD126001	41.00	6.35	9.50
FD126002	41.00	6.35	9.50

127 敏仔圓角刀

CLASSICAL BIT

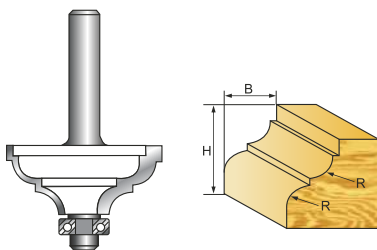

Part No.	D	H	B	R
FD127001	32.00	14.00	9.50	4.00
FD127002	40.00	18.00	13.50	6.00
FD127003	50.00	22.00	18.50	8.00

ROUTER BITS

128 台阶敏仔刀

STEP BEADING BIT

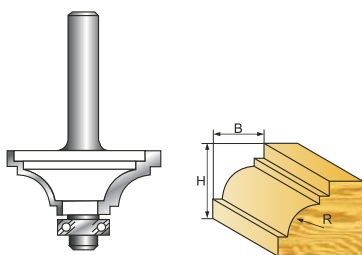

Part No.	D	H	B	R
FD128001	33.00	14.00	10.00	6.00
FD128002	38.00	16.00	12.50	8.00
FD128003	42.00	18.00	14.50	10.00

129 户西跳桌刀

HANDRAIL CLASSICAL BIT

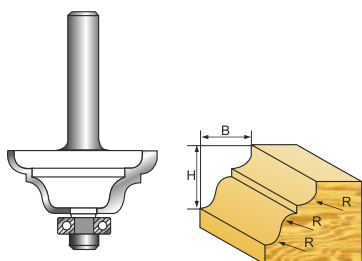

Part No.	D	H	B	R
FD129001	38.00	16.00	12.50	4.00
FD129002	50.00	22.00	18.50	6.00

130 跳桌框架线刀

HANDRAIL CLASSICAL BIT

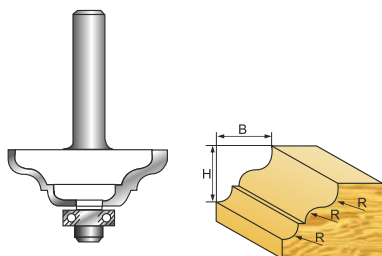

Part No.	D	H	B	R
FD130001	40.00	14.00	13.50	4.00
FD130002	53.00	20.00	20.00	6.00



方大工具 全球共享
FANGDA TOOLS GLOBAL SHARING

Add:Furong Industrial Zone, Yueqing City,Zhejiang P.R.China

Tel:0086-577-62295888 62298888 62299999

Fax:0086-577-62297777 P.C:325612

E-mail:fangda@chinafangda.cn

Http://www.fangdatools.com